

HY-BRID LIFTS™

BY CUSTOM EQUIPMENT LLC

MAINTENANCE & TROUBLESHOOTING MANUAL
SELF-PROPELLED AERIAL WORK PLATFORM

SUPO-696
REV A



HB-1230

SERIES III

Original instructions written in English

The purpose of this Maintenance Manual is to provide qualified service personnel with information for servicing and maintaining Hy-Brid Lifts. All information in this manual must be read and understood before any attempt is made to service this machine.

The operation and safety manual is considered a part of the work platform and contains instructions and operating procedures essential to properly and safely operate the Custom Equipment Hy-Brid Lift. Users must read and understand all information in the Safety and Operations Manual before operation.



**THE OPERATION AND SAFETY MANUAL MUST
BE READ AND UNDERSTOOD PRIOR TO OPERATING THE MACHINE.**

- The user/operator should not accept operating responsibility until the manual has been read and understood as well as having operated the lift under supervision of an experienced and qualified operator.
- Because the manufacturer has no direct control over machine application and operation, proper safety practices are the responsibility of the user and all operating personnel.



**ANY MODIFICATION ON THIS MACHINE WITH
OUT THE EXPRESS WRITTEN CONSENT OF THE MANUFACTURER IS PROHIBITED.**

TABLE OF CONTENTS

NOTES.....	2
FOREWORD	3
TABLE OF CONTENTS.....	4
INDEX OF FIGURES.....	5
SECTION 1 SAFETY	6
1.1 SAFETY SYMBOLS.....	6
1.2 GENERAL RULES AND PRECAUTIONS	6
1.3 SAFETY GUIDELINES.....	7
SECTION 2 MAINTENANCE	8
2.1 BATTERY MAINTENANCE.....	8
2.2 CHARGING THE BATTERY.....	8
2.3 LUBRICATION.....	10
2.4 COMPONENTS REQUIRING ADJUSTMENT	10
2.5 EXAMINATION, REPAIR, REPLACEMENT OF LIMITED LIFE COMPONENTS	10
2.6 SAFETY DEVICES AND SYSTEMS REQUIRING CHECKS	10
2.7 STORAGE	10
2.8 MAJOR ALTERATIONS OR REPAIRS.....	10
SECTION 3 MAINTENANCE CHECKLISTS	11
3.1 PRE-START INSPECTION CHECKLIST.....	12
3.2 PRE-DELIVERY/ANNUAL/FREQUENT INSPECTION CHECKLIST.....	13
SECTION 4 TECHNICAL REFERENCES	14
4.1 HYDRAULIC SCHEMATIC	14
4.2 ELECTRICAL SCHEMATIC	16
4.3 CONTROL BOARD DIAGNOSTIC.....	18
SECTION 5 WIRING DIAGRAMS.....	20
5.1 WIRING DIAGRAM	20
5.2 LWR CTL WIRING DIAGRAM	22
5.3 UPPER CONTROLS WIRING DIAGRAM.....	24
SECTION 6 TROUBLESHOOTING FLOWCHARTS	26
6.1 MAIN POWER/SAFETY CIRCUIT	26
6.2 DRIVE CIRCUIT	28
6.3 ELEVATE CIRCUIT	30
6.4 LOWER CIRCUIT.....	32
SECTION 7 PARTS.....	34
SECTION 8 WARRANTY.....	36
SECTION 9 INSPECTION AND REPAIR LOG	38

INDEX OF FIGURES

FIGURE 1: Maintenance Lock Use 7
FIGURE 2: Maintenance Lock Storage..... 7
FIGURE 3: Battery Charger LED Display..... 11

SECTION 1 | SAFETY

1.1 | SAFETY SYMBOLS



FAILURE TO FOLLOW THIS WARNING WILL CAUSE DEATH OR PERSONAL INJURY.

“DANGER” indicates an imminently hazardous situation, which, if not avoided, will result in death or serious injury.



FAILURE TO FOLLOW THIS WARNING MAY CAUSE DEATH OR PERSONAL INJURY.

“WARNING” indicates a potentially hazardous situation, which, if not avoided, could result in death or serious injury



FAILURE TO FOLLOW THIS WARNING MAY CAUSE INJURY OR DAMAGE TO EQUIPMENT.

“CAUTION” indicates a potentially hazardous situation which, if not avoided, could result in minor or moderate injury or damage to equipment

1.2 | GENERAL RULES AND PRECAUTIONS

An operator of any type of work platform is subject to certain hazards that cannot be protected by mechanical means. It is therefore essential that operators be competent, careful, physically and mentally fit and thoroughly trained in safe operation of this machine.

Although Custom Equipment, LLC conforms to specified ANSI & OSHA, it is the responsibility of the owner to instruct operators with the safety requirements made not only by Custom Equipment, LLC, but by the various safety boards in your area, as well as additional requirements set forth by ANSI and OSHA. If you come across a situation that you think might be unsafe, stop the platform and request further information from qualified sources before proceeding.



MAINTENANCE INFORMATION IS FOR USE BY TRAINED PERSONNEL ONLY



NEVER REACH BETWEEN SCISSORS LINKS OR PROP UP PLATFORM UNLESS MAINTENANCE PINS ARE IN PLACE

HY-BRID LIFTS™

1.3 | SAFETY GUIDELINES

Maintenance Lock

The maintenance lock must be placed into position whenever the machine is being serviced in the raised or partially raised position. Serious injury and/or death could result if maintenance lock is not used properly.

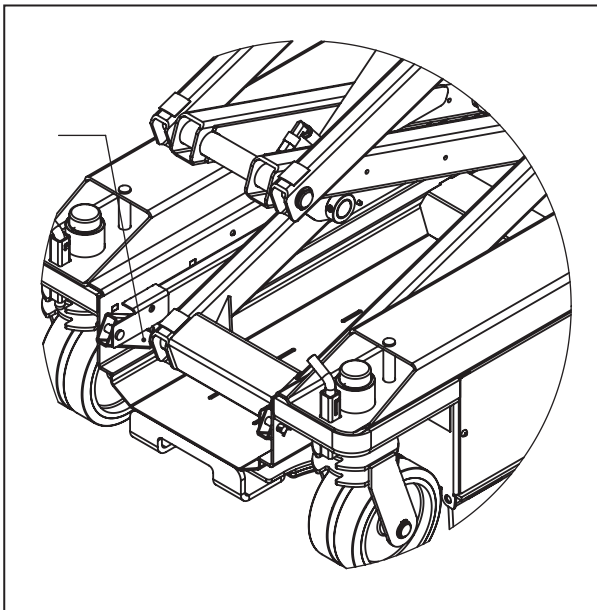

FIGURE 1: Maintenance Lock Use

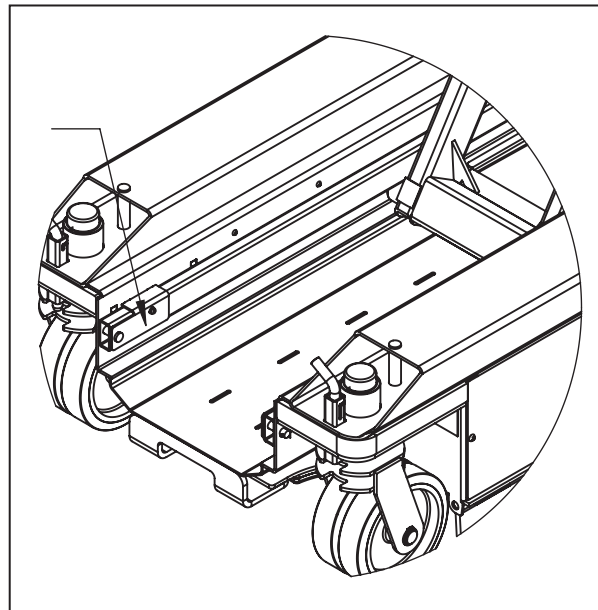

FIGURE 2: Maintenance Lock Storage



FAILURE TO COMPLY WITH THE LISTED SAFETY PRECAUTIONS MAY RESULT IN MACHINE DAMAGE, PERSONNEL INJURY, OR DEATH.

Other Guidelines

- Never work under an elevated platform until maintenance locks have been engaged.
- Remove all rings, watches, and jewelry when performing any maintenance.
- Do not wear long hair unrestrained or loose fitting clothing and neckties which may become caught on or entangled in equipment.
- Observe and obey all warnings and cautions on machine and in manual.
- Keep oil, grease, water, etc. wiped from standing surfaces and handholds.
- Before making any adjustments, lubricating or performing any other maintenance, shut off all power controls.
- Battery should always be disconnected during replacement of electrical components.
- Keep all support equipment and attachments stowed in their proper place.
- Use only approved nonflammable cleaning solvents.
- After maintenance, inspect the machine as described for Pre-delivery.

SECTION 2 | MAINTENANCE

2.1 | BATTERY MAINTENANCE

This unit is equipped with 12-volt AGM maintenance-free batteries.

NOTE: The surrounding temperature greatly affects the power reserve within a battery.

EXAMPLE: A battery that is 100% charged at 80° F (27°C) drops to 65% at 32°F (0°C). At 0°F (-18°C), this battery will drop to 40% efficiency.



NEVER ADD ACID TO BATTERY!

2.2 | CHARGING THE BATTERY



**BATTERIES GENERATE EXPLOSIVE GASES. KEEP SPARKS AND FLAME AWAY FROM BATTERIES.
DO NOT SMOKE WHILE CHARGING.**

The charger is equipped with an interlock circuit. The unit will not operate while charging. Shortened battery life will result.

To charge:

- Park the machine on a level surface.
- Plug charger into AC outlet until charged.
- For best battery life, leave the charger plugged in until machine will be used again. The charger will maintain the battery charge.

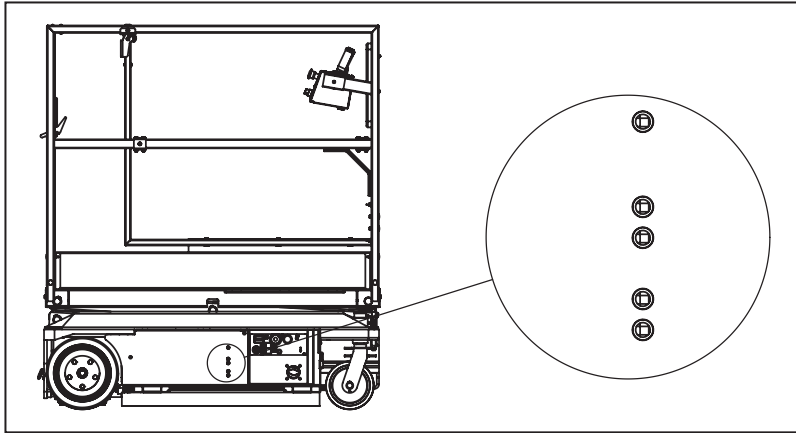

DO NOT OPERATE UNIT WHILE CHARGING. DO NOT DISABLE CHARGER INTERLOCK.

FIGURE 3: Battery Charger LED Display

How to read the battery displays

Power	Battery 1 Status		Battery 2 Status		This display indicates that the power is on but there is no connection to a battery. The charger must see approximately five (5) volts on a battery to deliver D/C current.
Charging	Ready	Charging	Ready		
					This display indicates that power is on and that both outputs are delivering D/C current to the batteries.
Green LED (ON)	Red LED (OFF)	Green LED (OFF)	Red LED (ON)	Green LED (OFF)	
Power	Battery 1 Status		Battery 2 Status		This display indicates that power is on and that both outputs are finished charging and are in a float maintenance mode.
Charging	Ready	Charging	Ready		
					A flashing red light indicates there is a problem with a battery, such as low voltage or a bad cell.
Green LED (ON)	Red LED (OFF)	Green LED (ON)	Red LED (OFF)	Green LED (ON)	
Power	Battery 1 Status		Battery 2 Status		
Charging	Ready	Charging	Ready		
Green LED (ON)	Red LED (FLASHING)	Green LED (ON)	Red LED (FLASHING)	Green LED (ON)	

2.3 | LUBRICATION

Item	Specification	Frequency of Lubrication
Wheels	Teflon Spray	Quarterly

2.4 | COMPONENTS REQUIRING ADJUSTMENT

Under normal use, no components should require adjustment. Contact the manufacturer if adjustments are required.

2.5 | EXAMINATION, REPAIR, REPLACEMENT OF LIMITED LIFE COMPONENTS

With proper use, regular battery charging, and regular inspection, there are no limited life components that require routine replacement.

2.6 | SAFETY DEVICES AND SYSTEMS REQUIRING CHECKS

Check safety functions as part of daily inspection. Check that the brakes are holding.

2.7 | STORAGE

After periods of storage, exposure to extremes of ambient conditions-heat, cold, moisture, dust etc. inspect the machine. Batteries will need to be charged. Refer to the Pre-Delivery/ Frequent Inspection Checklist in the Maintenance Manual.

2.8 | MAJOR ALTERATIONS OR REPAIRS

Any alterations must be approved by the manufacturer. Major repairs, which affect the stability, strength, or performance of the machine must also be approved by the manufacturer, recorded, and include machine inspection and testing. Never attach pipe racks, material lifting devices, or make any other alteration that is not part of the intended design of the machine.

SECTION 3 | MAINTENANCE CHECKLISTS



FAILURE TO PERFORM INSPECTIONS AND PREVENTATIVE MAINTENANCE AT RECOMMENDED INTERVALS MAY RESULT IN THE UNIT BEING OPERATED WITH A DEFECT THAT MAY RESULT IN INJURY OR DEATH OF THE OPERATOR.

Regular inspection and conscientious maintenance is important to efficient economical operation of this machine. It will help to assure that equipment will perform satisfactorily with a minimum of service and repair. Make checks at the stated intervals or more frequently if required by local operating conditions. The following inspection checklists are included in this manual:

- Pre-Start (required before operation at each work shift)
- Pre-Delivery/Frequent/Annual (Required every 3 months, after periods of storage, and after any alterations or repairs)

The rated life of the machine is Light Intermittent Duty (typical use 10 years, 40 weeks per year, 20 hours per week, 5 load cycles per hour).

SECTION 3 | MAINTENANCE CHECKLISTS

3.1 | PRE-START INSPECTION CHECKLIST

Pre-start Inspection (Self-Propelled Models)



THIS CHECKLIST MUST BE USED AT THE BEGINNING OF EACH SHIFT OR AFTER EVERY SIX TO EIGHT HOURS OF USE. FAILURE TO DO SO COULD AFFECT THE SAFETY OF THE OPERATOR.

Model: _____ Serial Number: _____

- Keep inspection records up-to-date.
- Record and report all discrepancies to your supervisor.
- A dirty machine cannot be properly inspected.

Y-Yes/Acceptable	N-No/Unacceptable	R-Repaired	N/A - Not equipped with this feature	Y	N	R	N/A
VISUAL INSPECTIONS							
There are no loose or missing parts.				<input type="checkbox"/>	<input type="checkbox"/>	<input type="checkbox"/>	<input type="checkbox"/>
Check that warning and instructional labels are legible and secure. Ensure that load capacity is clearly marked.				<input type="checkbox"/>	<input type="checkbox"/>	<input type="checkbox"/>	<input type="checkbox"/>
Check the platform rails and safety gate for damage.				<input type="checkbox"/>	<input type="checkbox"/>	<input type="checkbox"/>	<input type="checkbox"/>
Platform and base controls are not missing, damaged, or disconnected.				<input type="checkbox"/>	<input type="checkbox"/>	<input type="checkbox"/>	<input type="checkbox"/>
Electrical cables and wires are not torn, frayed, or disconnected.				<input type="checkbox"/>	<input type="checkbox"/>	<input type="checkbox"/>	<input type="checkbox"/>
Hydraulic hoses are not torn or loose, and there are no leaks. Hoses and the cables have no worn areas or chafing.				<input type="checkbox"/>	<input type="checkbox"/>	<input type="checkbox"/>	<input type="checkbox"/>
Check the tires for damage. Check that wheel axle retaining rings and any set screw(s) in rear wheel are tight.				<input type="checkbox"/>	<input type="checkbox"/>	<input type="checkbox"/>	<input type="checkbox"/>
Check that all snap rings are secure in grooves on pivot pins.				<input type="checkbox"/>	<input type="checkbox"/>	<input type="checkbox"/>	<input type="checkbox"/>
FUNCTIONAL TESTS							
Gate closes automatically and latches.				<input type="checkbox"/>	<input type="checkbox"/>	<input type="checkbox"/>	<input type="checkbox"/>
Platform Controls: Check all switches and push buttons for proper operation.							
Emergency Stop (Stops all movement)				<input type="checkbox"/>	<input type="checkbox"/>	<input type="checkbox"/>	<input type="checkbox"/>
For Actuator-Steered models: Enable Switch (Does not elevate unless enable is pressed)				<input type="checkbox"/>	<input type="checkbox"/>	<input type="checkbox"/>	<input type="checkbox"/>
For Counter-Rotate Steering models: Drive & Up/Down Mode Switch (Selects drive/steer or elevate mode)				<input type="checkbox"/>	<input type="checkbox"/>	<input type="checkbox"/>	<input type="checkbox"/>
Joystick (Return to neutral, drives forward & reverse.)				<input type="checkbox"/>	<input type="checkbox"/>	<input type="checkbox"/>	<input type="checkbox"/>
Enable Trigger (Must be activated for joystick-operated movement)				<input type="checkbox"/>	<input type="checkbox"/>	<input type="checkbox"/>	<input type="checkbox"/>
For Actuator-Steered models: Thumb rocker steers right & left				<input type="checkbox"/>	<input type="checkbox"/>	<input type="checkbox"/>	<input type="checkbox"/>
For Counter-Rotate Steering models: Elevates & lowers				<input type="checkbox"/>	<input type="checkbox"/>	<input type="checkbox"/>	<input type="checkbox"/>
If so equipped, horn sounds when button is pressed.				<input type="checkbox"/>	<input type="checkbox"/>	<input type="checkbox"/>	<input type="checkbox"/>
Base Controls: Check all switches and push buttons for proper operation.							
Emergency Stop (Stops all movement)				<input type="checkbox"/>	<input type="checkbox"/>	<input type="checkbox"/>	<input type="checkbox"/>
For Actuator-Steered models: Key Switch (On or Off)				<input type="checkbox"/>	<input type="checkbox"/>	<input type="checkbox"/>	<input type="checkbox"/>
For Counter-Rotate Steering models: Key Switch (Selects Platform Control, Ground Control, or Off)				<input type="checkbox"/>	<input type="checkbox"/>	<input type="checkbox"/>	<input type="checkbox"/>
Up/Down Rocker Switch (Elevates, Lowers)				<input type="checkbox"/>	<input type="checkbox"/>	<input type="checkbox"/>	<input type="checkbox"/>
Descent Alarm (Not damaged, sounds for descent; may also sound for drive & elevate, if so equipped)				<input type="checkbox"/>	<input type="checkbox"/>	<input type="checkbox"/>	<input type="checkbox"/>
Tilt Alarm (Not damaged, sounds when tilted and machine elevated above designated height)				<input type="checkbox"/>	<input type="checkbox"/>	<input type="checkbox"/>	<input type="checkbox"/>
If so equipped, elevating beyond this height may also be prevented.				<input type="checkbox"/>	<input type="checkbox"/>	<input type="checkbox"/>	<input type="checkbox"/>
Master Power Switch disconnects battery				<input type="checkbox"/>	<input type="checkbox"/>	<input type="checkbox"/>	<input type="checkbox"/>
Wheels: Front and rear wheels rotate freely.				<input type="checkbox"/>	<input type="checkbox"/>	<input type="checkbox"/>	<input type="checkbox"/>
For Counter-Rotate Steering models: Front wheels pivot freely.				<input type="checkbox"/>	<input type="checkbox"/>	<input type="checkbox"/>	<input type="checkbox"/>
Drives in slow speed when elevated.				<input type="checkbox"/>	<input type="checkbox"/>	<input type="checkbox"/>	<input type="checkbox"/>
Brakes: Machine stops when joystick released.				<input type="checkbox"/>	<input type="checkbox"/>	<input type="checkbox"/>	<input type="checkbox"/>
Pothole guards deploy and lock when platform is elevated.				<input type="checkbox"/>	<input type="checkbox"/>	<input type="checkbox"/>	<input type="checkbox"/>
Lift does not elevate when pothole guards are blocked.				<input type="checkbox"/>	<input type="checkbox"/>	<input type="checkbox"/>	<input type="checkbox"/>

Date: _____ Inspected by: _____

HY-BRID LIFTS™

3.2 | PRE-DELIVERY/ANNUAL/FREQUENT INSPECTION CHECKLIST



AERIAL PLATFORMS SHALL BE INSPECTED, SERVICED, AND ADJUSTED TO MANUFACTURER’S REQUIREMENTS BY A QUALIFIED MECHANIC PRIOR TO EACH SALE, LEASE, OR RENTAL, AND EVERY 3 MONTHS OR 150 HOURS, WHICHEVER COMES FIRST, AND ANNUALLY.

Model: _____ Serial Number: _____

- Check each item listed below.
- Use proper operating, service, and maintenance manual for specific information and settings
- If an item is found to be unacceptable make the necessary repairs and check the “repaired” box.
- When all items are “acceptable”, the unit is ready for service.
- If an item is found to be unacceptable, make the necessary repairs and check the “repaired” box. When all items are “acceptable,” the unit is ready for service.

Y – Yes/Acceptable N – No/Unacceptable R – Repaired N/A – Not equipped with this feature

	Y	N	R	N/A		Y	N	R	N/A
Base:					Rails/Extending platform:				
Inspect slide tracks for damage	<input type="checkbox"/>	<input type="checkbox"/>	<input type="checkbox"/>	<input type="checkbox"/>	Extends freely	<input type="checkbox"/>	<input type="checkbox"/>	<input type="checkbox"/>	<input type="checkbox"/>
All frame bolts tight	<input type="checkbox"/>	<input type="checkbox"/>	<input type="checkbox"/>	<input type="checkbox"/>	Cables in place/secure	<input type="checkbox"/>	<input type="checkbox"/>	<input type="checkbox"/>	<input type="checkbox"/>
Pump Secure	<input type="checkbox"/>	<input type="checkbox"/>	<input type="checkbox"/>	<input type="checkbox"/>	Locks in Stowed Position	<input type="checkbox"/>	<input type="checkbox"/>	<input type="checkbox"/>	<input type="checkbox"/>
DC motors secure	<input type="checkbox"/>	<input type="checkbox"/>	<input type="checkbox"/>	<input type="checkbox"/>	Locks in Extended Position	<input type="checkbox"/>	<input type="checkbox"/>	<input type="checkbox"/>	<input type="checkbox"/>
Batteries Fully Charged	<input type="checkbox"/>	<input type="checkbox"/>	<input type="checkbox"/>	<input type="checkbox"/>	Functions:				
For actuator-steered models: Tie rods secure	<input type="checkbox"/>	<input type="checkbox"/>	<input type="checkbox"/>	<input type="checkbox"/>	All Functions (Drive,Elevate,Steer) Operational (see Pre-Start Inspection for details)	<input type="checkbox"/>	<input type="checkbox"/>	<input type="checkbox"/>	<input type="checkbox"/>
Wheels:					Pothole guards deploy when platform elevated	<input type="checkbox"/>	<input type="checkbox"/>	<input type="checkbox"/>	<input type="checkbox"/>
Snap Rings Secure	<input type="checkbox"/>	<input type="checkbox"/>	<input type="checkbox"/>	<input type="checkbox"/>	Emergency Stop Breaks Circuits	<input type="checkbox"/>	<input type="checkbox"/>	<input type="checkbox"/>	<input type="checkbox"/>
Bolts/Nuts Tight	<input type="checkbox"/>	<input type="checkbox"/>	<input type="checkbox"/>	<input type="checkbox"/>	Slow Speed limit switch Set properly	<input type="checkbox"/>	<input type="checkbox"/>	<input type="checkbox"/>	<input type="checkbox"/>
All Shields/Guards in place	<input type="checkbox"/>	<input type="checkbox"/>	<input type="checkbox"/>	<input type="checkbox"/>	Pothole interlock functions correctly	<input type="checkbox"/>	<input type="checkbox"/>	<input type="checkbox"/>	<input type="checkbox"/>
Scissors:					Brakes: Operational	<input type="checkbox"/>	<input type="checkbox"/>	<input type="checkbox"/>	<input type="checkbox"/>
No Broken Welds	<input type="checkbox"/>	<input type="checkbox"/>	<input type="checkbox"/>	<input type="checkbox"/>	Emergency Down Operational	<input type="checkbox"/>	<input type="checkbox"/>	<input type="checkbox"/>	<input type="checkbox"/>
No Bent Beam Members	<input type="checkbox"/>	<input type="checkbox"/>	<input type="checkbox"/>	<input type="checkbox"/>	Wiring:				
All rollers Turn Freely	<input type="checkbox"/>	<input type="checkbox"/>	<input type="checkbox"/>	<input type="checkbox"/>	Switches secure	<input type="checkbox"/>	<input type="checkbox"/>	<input type="checkbox"/>	<input type="checkbox"/>
Ret. Rings Secure On Pivots	<input type="checkbox"/>	<input type="checkbox"/>	<input type="checkbox"/>	<input type="checkbox"/>	Contactors secure	<input type="checkbox"/>	<input type="checkbox"/>	<input type="checkbox"/>	<input type="checkbox"/>
Maintenance Locks: Stored in designated location	<input type="checkbox"/>	<input type="checkbox"/>	<input type="checkbox"/>	<input type="checkbox"/>	Tight on terminals (No loose wiring)	<input type="checkbox"/>	<input type="checkbox"/>	<input type="checkbox"/>	<input type="checkbox"/>
Platform:					Oil: Level 1" from top (when platform stowed)	<input type="checkbox"/>	<input type="checkbox"/>	<input type="checkbox"/>	<input type="checkbox"/>
No Bent rails	<input type="checkbox"/>	<input type="checkbox"/>	<input type="checkbox"/>	<input type="checkbox"/>	Check all hose for leaks	<input type="checkbox"/>	<input type="checkbox"/>	<input type="checkbox"/>	<input type="checkbox"/>
No Broken welds	<input type="checkbox"/>	<input type="checkbox"/>	<input type="checkbox"/>	<input type="checkbox"/>	Check all fittings for leaks	<input type="checkbox"/>	<input type="checkbox"/>	<input type="checkbox"/>	<input type="checkbox"/>
All rails in place/secure	<input type="checkbox"/>	<input type="checkbox"/>	<input type="checkbox"/>	<input type="checkbox"/>	Battery Charger Secure/Operational	<input type="checkbox"/>	<input type="checkbox"/>	<input type="checkbox"/>	<input type="checkbox"/>
110V outlet safe/working (if applicable)	<input type="checkbox"/>	<input type="checkbox"/>	<input type="checkbox"/>	<input type="checkbox"/>	Tilt sensor	<input type="checkbox"/>	<input type="checkbox"/>	<input type="checkbox"/>	<input type="checkbox"/>
Entrance gate Closes Freely	<input type="checkbox"/>	<input type="checkbox"/>	<input type="checkbox"/>	<input type="checkbox"/>	Warning Horn (if applicable)	<input type="checkbox"/>	<input type="checkbox"/>	<input type="checkbox"/>	<input type="checkbox"/>
Decals:					Hour meter operational	<input type="checkbox"/>	<input type="checkbox"/>	<input type="checkbox"/>	<input type="checkbox"/>
Legibile	<input type="checkbox"/>	<input type="checkbox"/>	<input type="checkbox"/>	<input type="checkbox"/>	Battery indication operational	<input type="checkbox"/>	<input type="checkbox"/>	<input type="checkbox"/>	<input type="checkbox"/>
Correct capacity noted	<input type="checkbox"/>	<input type="checkbox"/>	<input type="checkbox"/>	<input type="checkbox"/>	Operator’s Manual is on the unit	<input type="checkbox"/>	<input type="checkbox"/>	<input type="checkbox"/>	<input type="checkbox"/>
Proper placement & quantity	<input type="checkbox"/>	<input type="checkbox"/>	<input type="checkbox"/>	<input type="checkbox"/>	If equipped with load sensing: Overload light & alarm sounds when overloaded	<input type="checkbox"/>	<input type="checkbox"/>	<input type="checkbox"/>	<input type="checkbox"/>

Date: _____ Inspected by: _____



SECTION 4 | TECHNICAL REFERENCES

4.1 | HYDRAULIC SCHEMATIC

Part No. HS-129-20-201-50

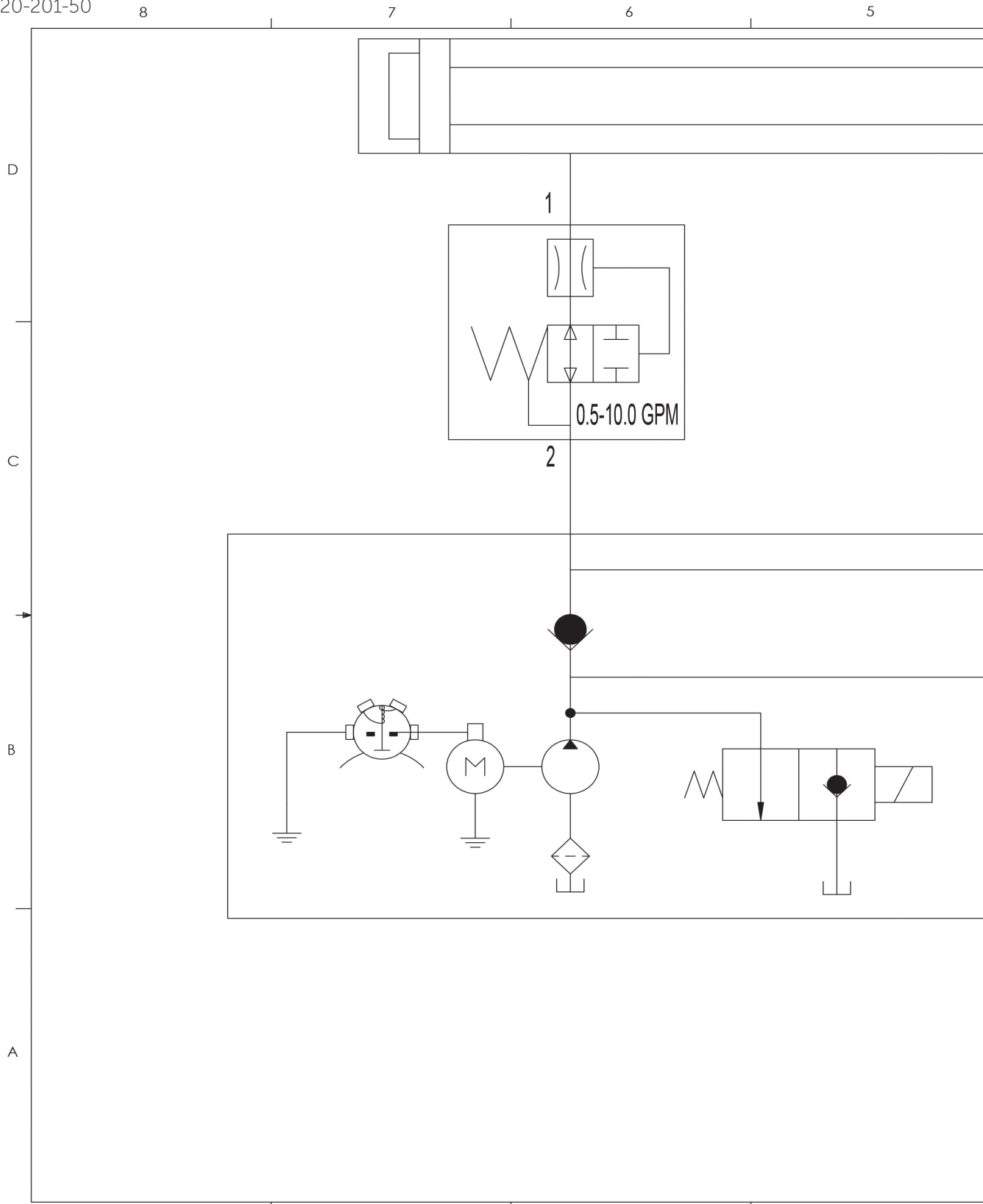

8 THIS DRAWING IS CONFIDENTIAL AND PROPRIETARY TO CUSTOM EQUIPMENT AND IS LOANED IN EXPECTATION OF PROTECTIVE ORDER

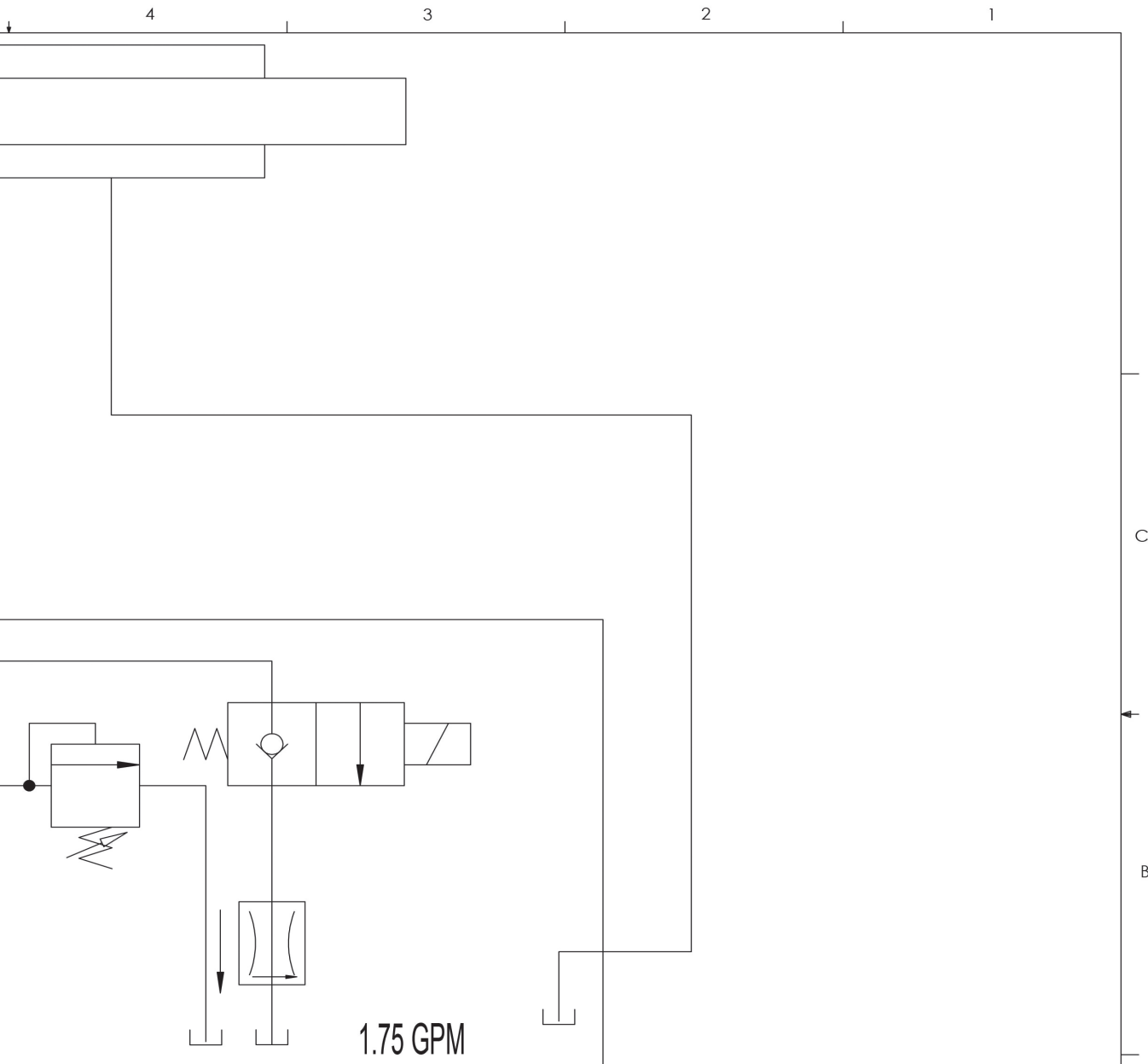

REV	DESCRIPTION OF CHANGE	ECO #	DATE	REV BY
B	1.75 GPM Flow Control was 2.5 GPM	2015-2555	05/11/2015	GLH
ORIGINALLY DRAWN BY:		DATE:		
Custom Equipment, Inc.		Richfield, WI 53076 Phone: (262)644-1300		
HYDR SCH, HB-830/1230 S2				
SPEC/MATL: Schematic		WEIGHT: APPROX. 0.00 LB.		
DRAWING #: HS-129-20-201-50				B
SCALE: 1:1	B-SIZE	DO NOT SCALE DRAWING	SHEET 1 OF 3	

STATEMENT THAT IT WILL BE KEPT CONFIDENTIAL AND USED ONLY FOR THE PURPOSE FOR WHICH IT IS LOANED.¹

4.2 | ELECTRICAL SCHEMATIC

Part No. WS-129-20-316-50

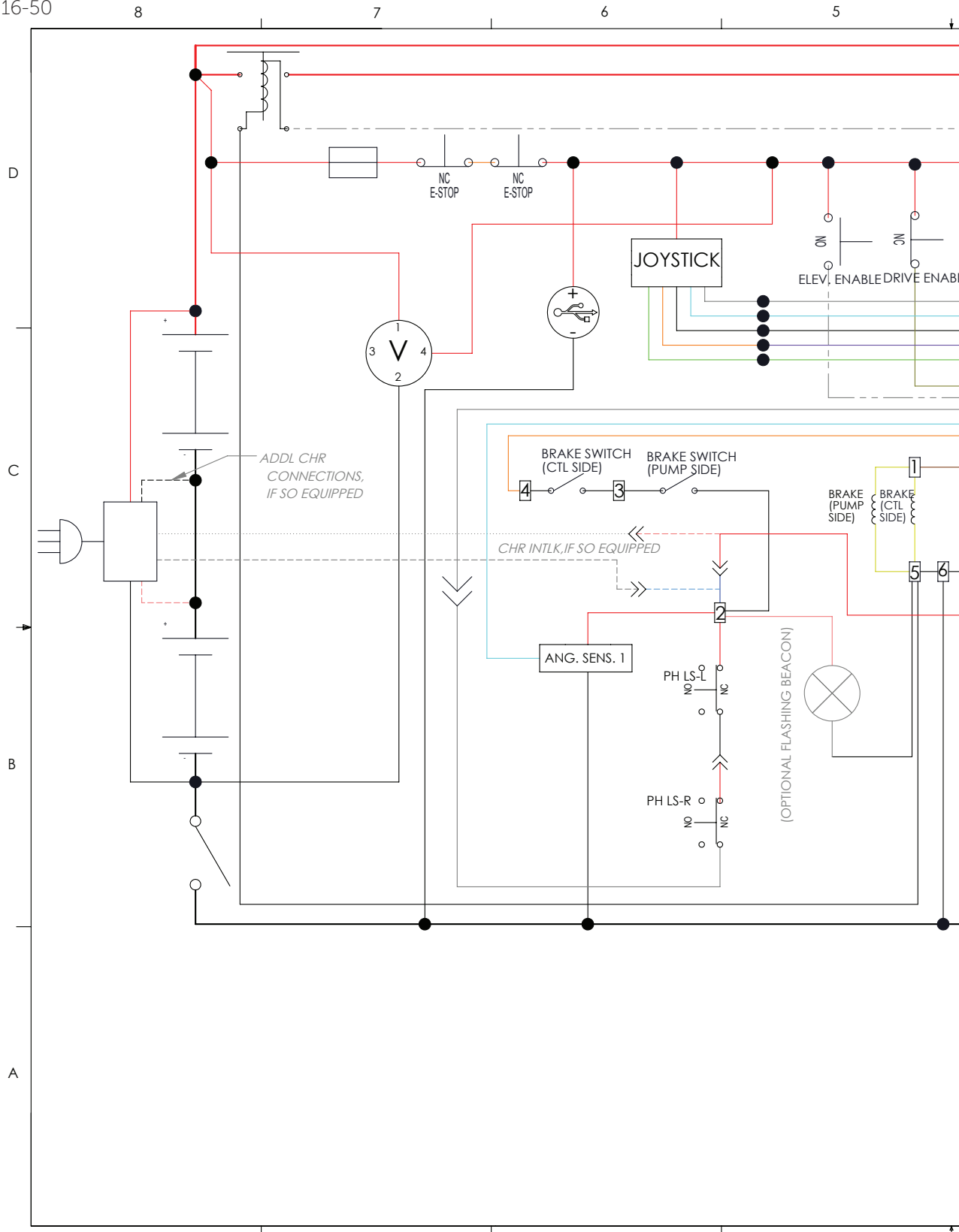

THIS DRAWING IS CONFIDENTIAL AND PROPRIETARY TO CUSTOM, EQUIPMENT AND IS LOANED IN EXPECTATION OF YOUR BUSINESS.

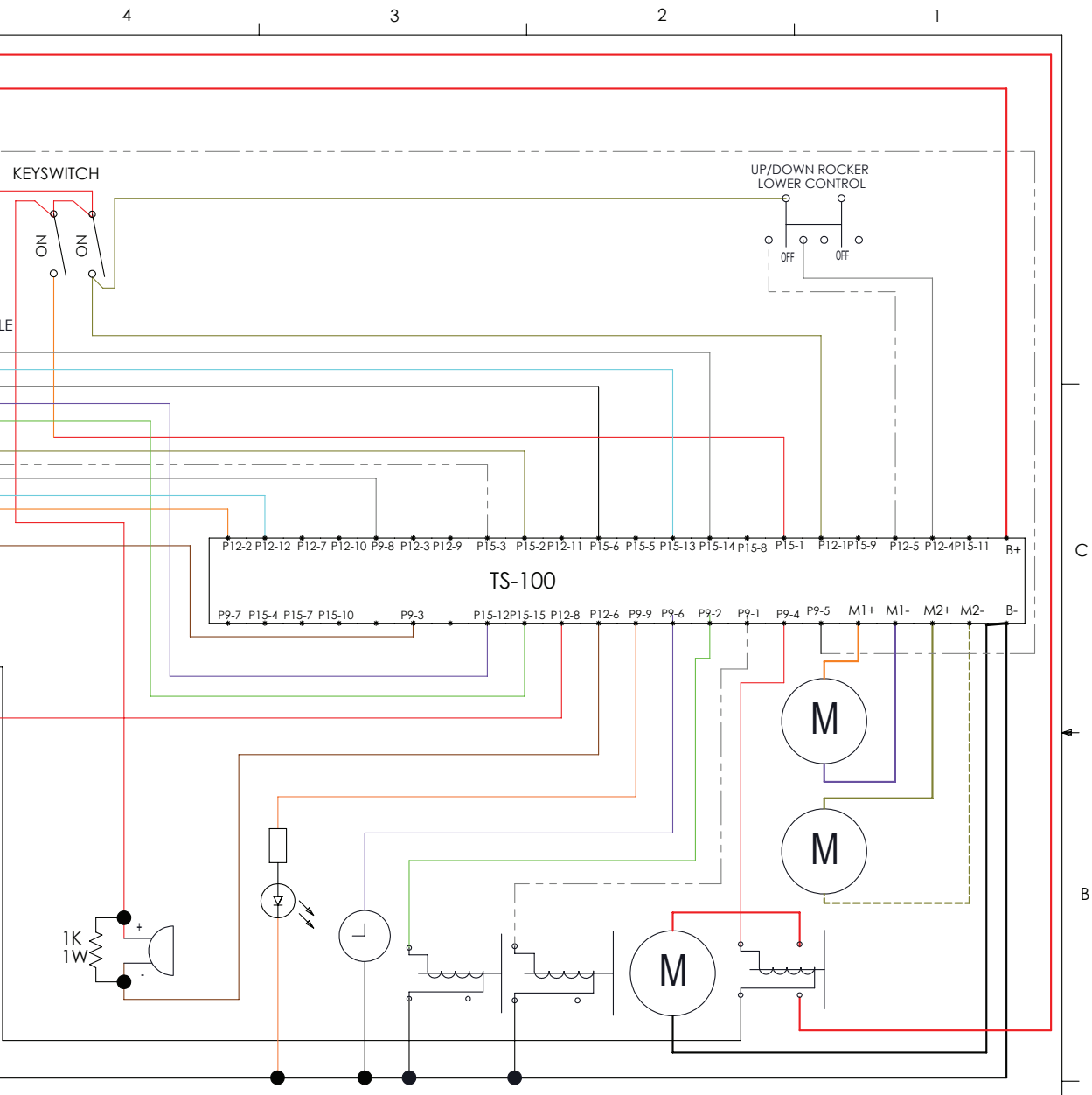

REV	DESCRIPTION OF CHANGE	ECO #	DATE	REV BY
C	Revise Charger Wiring (Lester Chgr)	2017-3156	07/10/2017	GLH
ORIGINALLY DRAWN BY:		DATE:		
Custom Equipment, Inc.		Richfield, WI 53076 Phone: (262)644-1300		
ELEC SCH, HB-1230 S3				
SPEC/MATL: Schematic		WEIGHT: APPROX. 0.00 LB.		
DRAWING #: WS-129-20-316-50				C
SCALE: 1:1	B-SIZE	DO NOT SCALE DRAWING	SHEET 1 OF 1	

NOTATION THAT IT WILL BE KEPT CONFIDENTIAL AND USED ONLY FOR THE PURPOSE FOR WHICH IT IS LOANED.

4.3 | CONTROL BOARD DIAGNOSTIC

When using the LED for diagnosis, note that a DUAL FLASH code is indicated. The LED will flash on/off a certain number of times, pause off for a short delay, then flash on/off a second certain number of times, followed by a much longer pause off. The sequence will then repeat.

EXAMPLE: The LED flash code 3-2 will look like: on/off/on/off/on/off-short-delay/on/off/on/off-long-delay/repeat

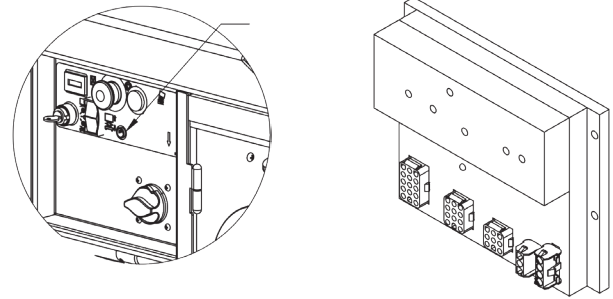

LED Code	Possible Cause
Fast Flash	Control Module is not calibrated, Do not operate unit.
Steady	Unit has just been powered on. You may need to wait for initialization, then re-select function. Ready to operate, things should be working normally. A function is selected but the enable trigger is not squeezed.
1-1	The control module is not calibrated. Do not use this unit.
2-1	The key switch selector switch indicate the mode in which the TS100 must operate. If neither input is active, or if both are active together, the TS100 does not know how to function. Check key switch and wiring to P15-1 and P12-1.
2-2	A safety feature is locking functions or a switch has failed. Check that platform is not overloaded, operating on a level surface, and pothole guards deploy/ Check that joystick is neutral when powered on. Check that joystick trigger is not closed for too long without selecting a function. Check for failed joystick, selector switches, and up/down switches.
3-x	There is a problem with the drive contactor or valve wiring, or with the motor power wiring; disconnect connector P9 to see if the problem is caused by drive contactor or valve wiring (if the fault clears, check for an illegal B+ supply in to P9) Check motor power wiring; with the drive contactor open the B+ power terminals should be at 10V-15V (significantly lower than B+) If the LED is steady at power-on, and the fault (3-5) occurs after a delay when attempting to drive or lift, the motor may be stalled and causing an overload of the TS100 or there is a power wiring error like connecting the B+ cable to a motor stud
3-2	Check P9 wiring. One or more signals showing outputs when all should be off.
3-3	Check B+ stud connections on controller. Voltage is too high.
3-4	There is voltage on safe pre-valve supply when there should not be. Controller may need to be replaced.
3-5	The drive brake current is too high. Motor overload. Check for a siezed motor or for power wiring to motors.
4-x	There is a problem with battery supply, the height and/or pressure sensors, the supply to them, or the temperature sensor inside the TS100 Check battery supply to EMS inputs P15-1 or P12-1 (relative to the B- stud); the battery supply should be between 15V and 32V Check the output from height sensor (P12-12) If the TS100 heatsink is very hot then perhaps the controller has temporarily shut down – if so, platform lowering is still allowed; wait for the controller to cool down
4-2	Functions Locked: Board is overheated. Check pump, drive motor wiring. Problem with controller internal voltage. Controller may need to be replaced.

4-3	Problem with controller internal voltage. Controller may need to be replaced.
4-4	Battery supply is too low or too high. Make sure batteries are fully charged. Do not operate while charging.
4-5	Joystick signal problem. Wiring problem-check for short circuits, misconnection, check P15-12 connection.
6-x	There is a problem with the height measurements, or the elevation switch disagrees with the height sensor. Check that the output from height sensor (P12-12) is in range (between 0.5V and 4.5V)
6-1	Problem with angle sensor or its connections
6-2	This feature does not apply on ANSI/CSA models.
6-3	Problem with elevation switch or its connections
6-6	This feature does not apply on ANSI/CSA models.
7-x	There is a problem with the power wiring – the voltage on the B+ stud is too low Check for a short-circuit to the B+ stud
7-1	Motor A current too high.
7-2	Motor A current too low.
7-3	Motor B current too high.
7-4	Motor B current too low.
7-5	Check drive connections at both drives--short or multiple wiring faults.
7-7	Check B+ stud connections on controller. Voltage is too low.

SECTION 5 | WIRING DIAGRAMS

5.1 | WIRING DIAGRAM

Part No. WD-129-20-316-50

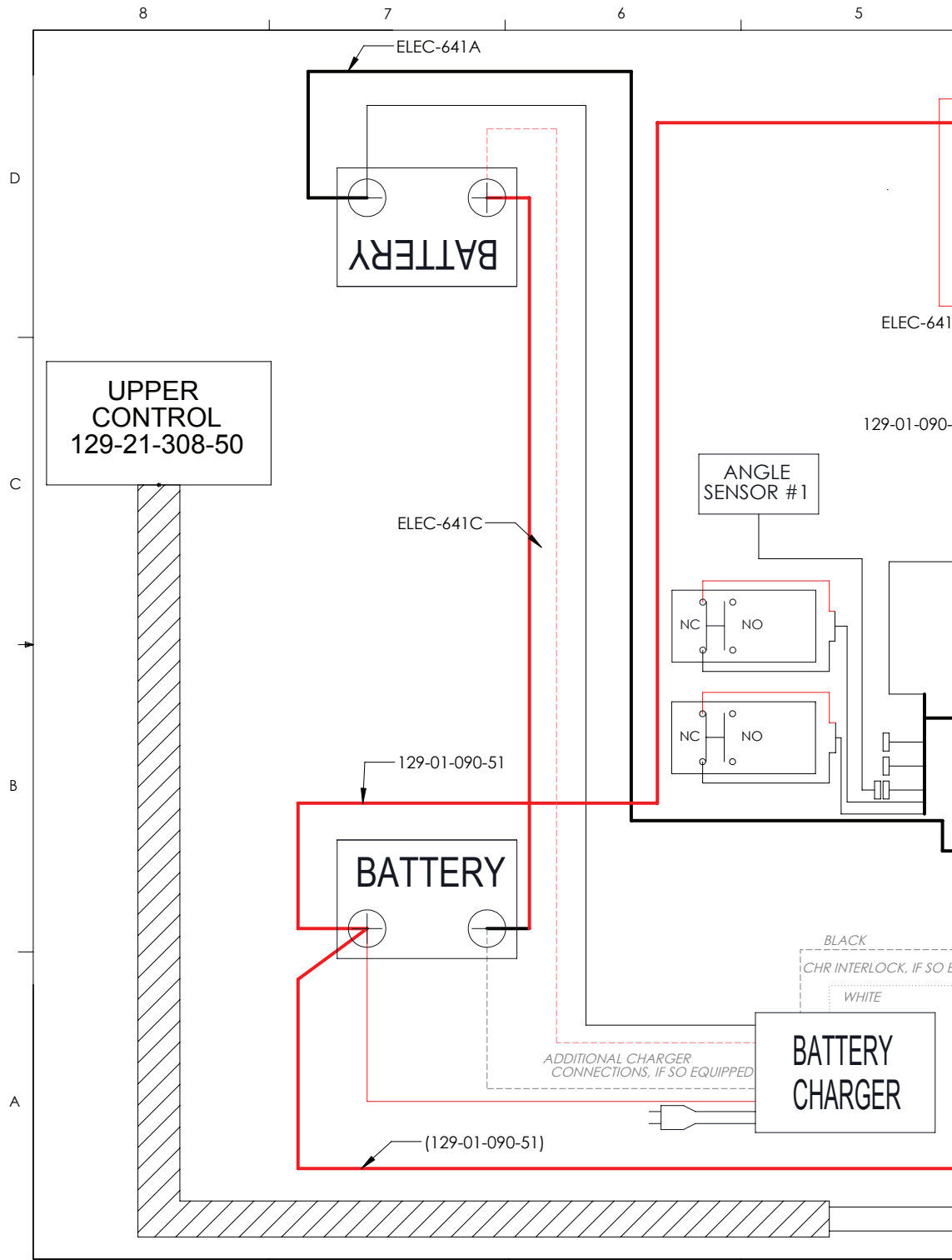

8 THIS DRAWING IS CONFIDENTIAL AND PROPRIETARY TO CUSTOM, EQUIPMENT AND IS LOANED IN EX

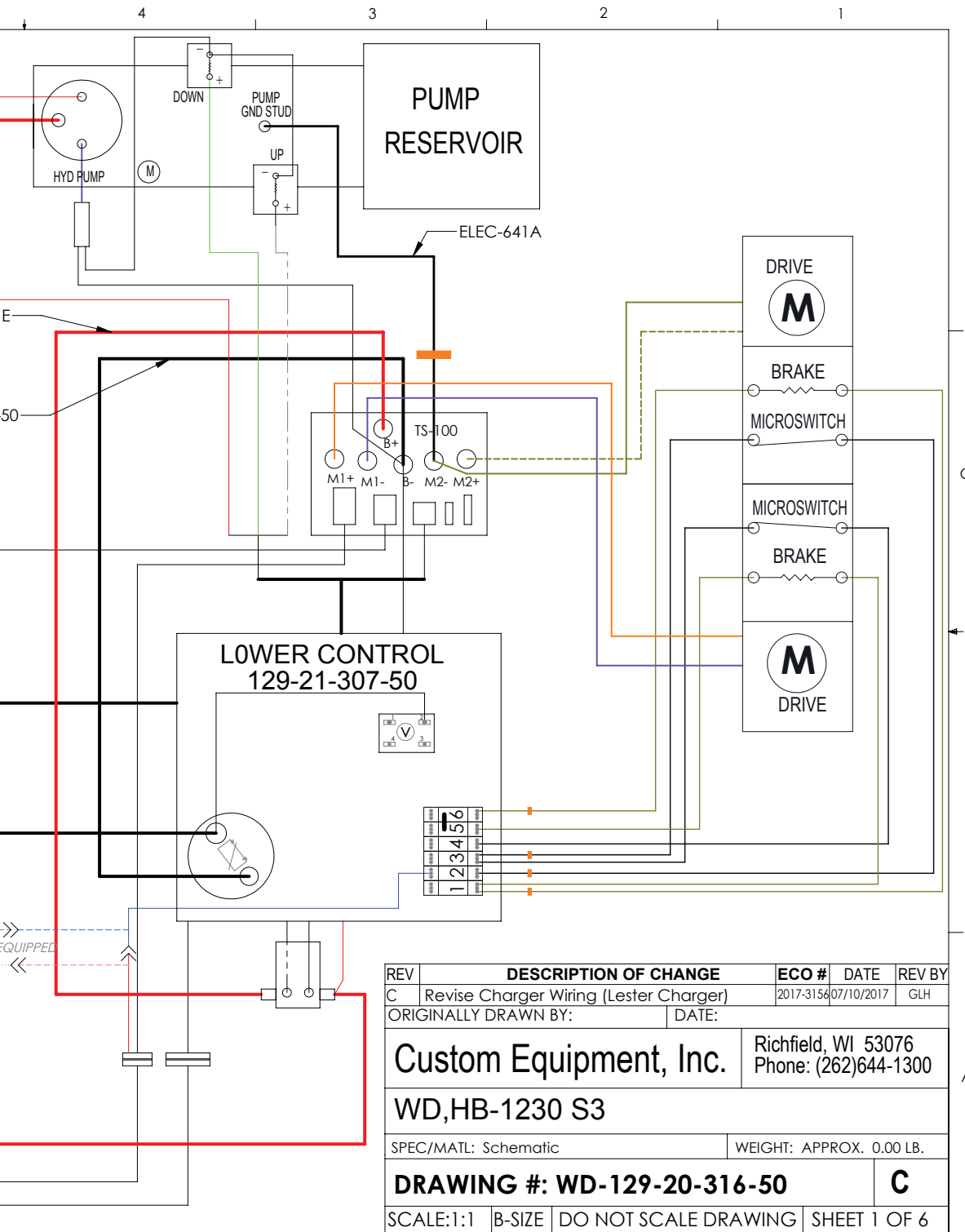

EXPECTATION THAT IT WILL BE KEPT CONFIDENTIAL AND USED ONLY FOR THE PURPOSE FOR WHICH IT IS LOANED.

5.2 | LWR CTL WIRING DIAGRAM

Part No. WD-129-21-307-50

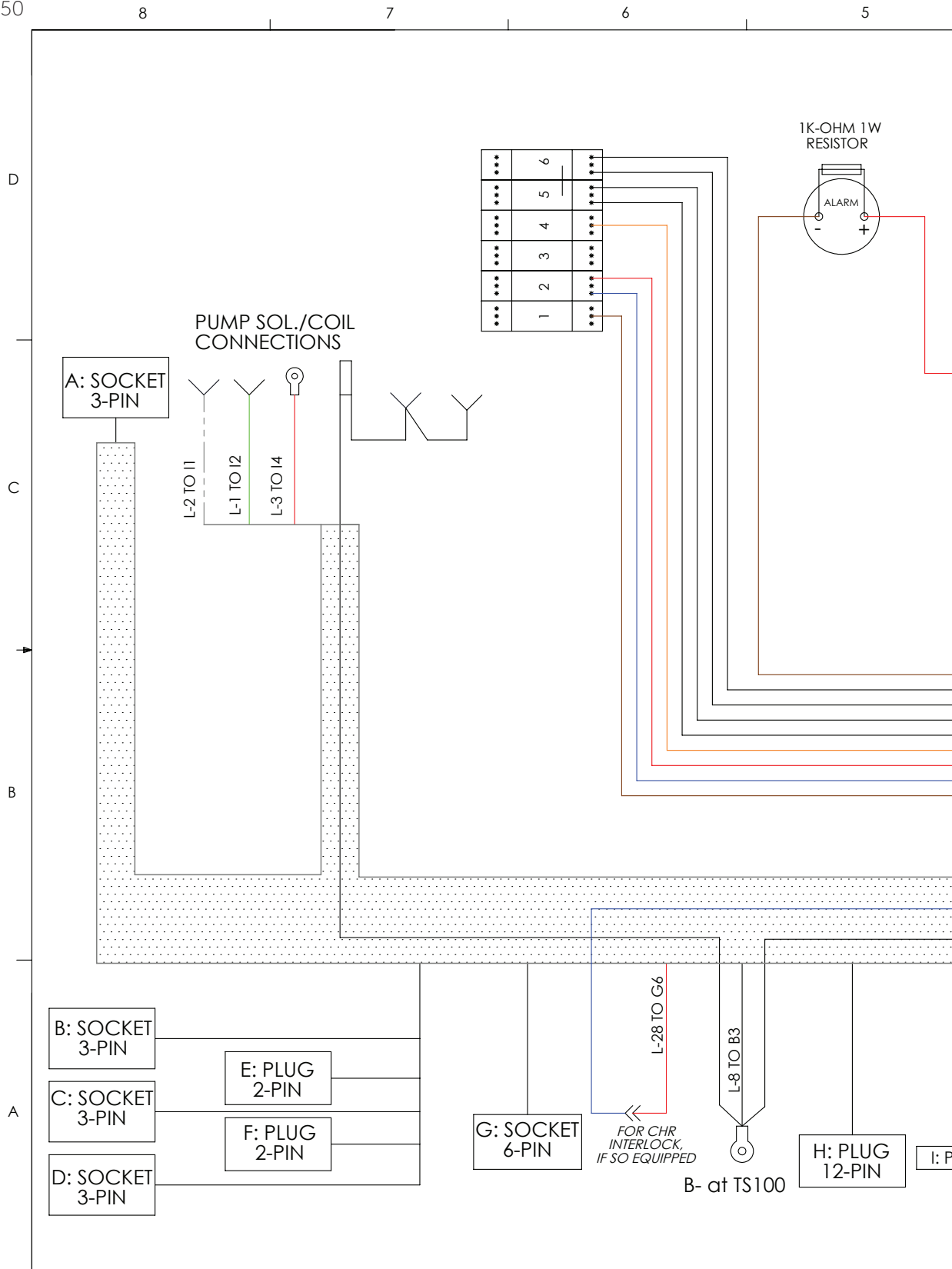

THIS DRAWING IS CONFIDENTIAL AND PROPRIETARY TO CUSTOM, EQUIPMENT AND IS LOANED IN EX

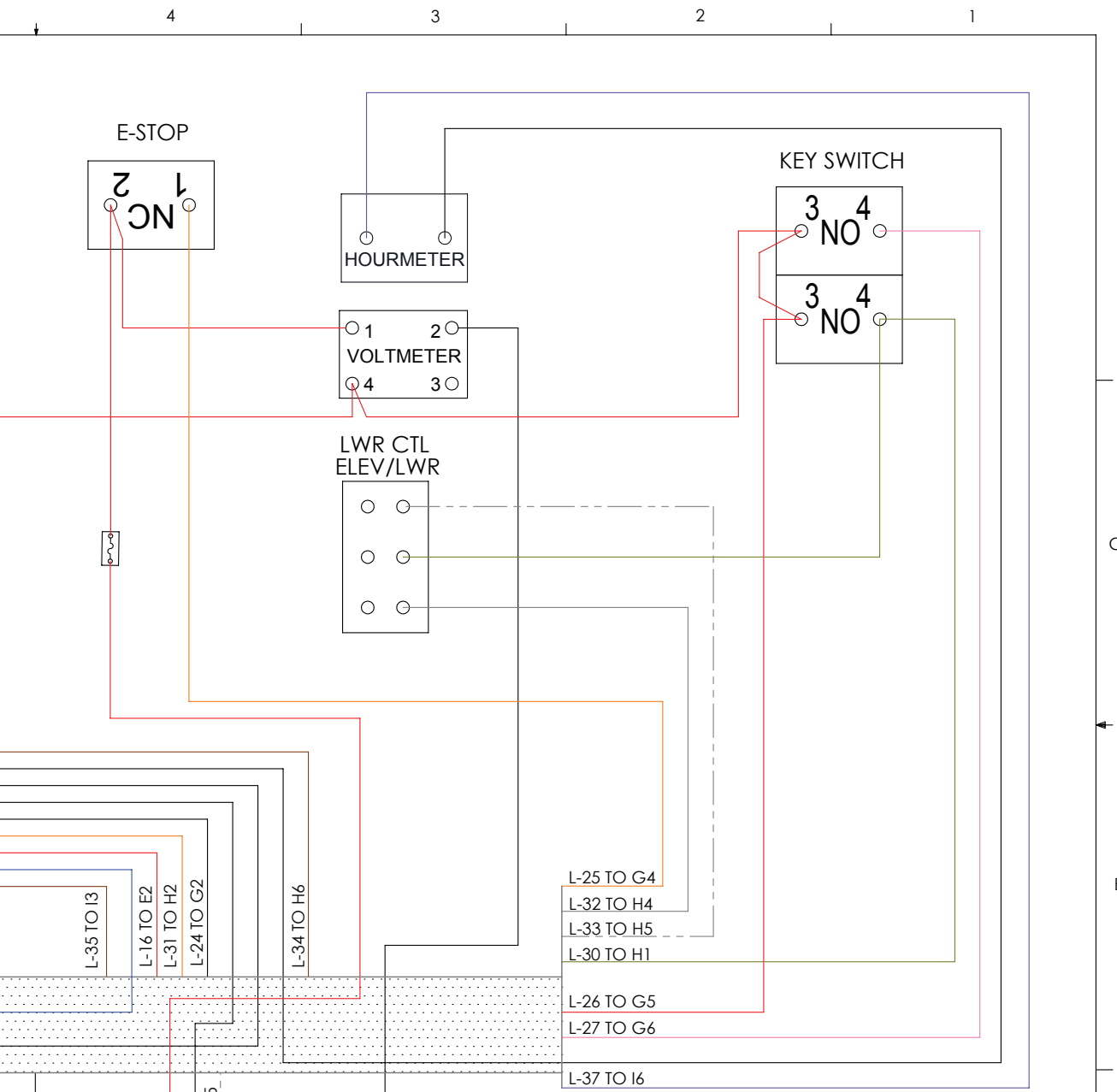

REV	DESCRIPTION OF CHANGE	ECO #	DATE	REV BY
B	CHR INTLK LEADS	2016-3054	03/01/2017	DJS
ORIGINALLY DRAWN BY:		DATE:		
Custom Equipment, Inc.		Richfield, WI 53076 Phone: (262)644-1300		
WD, LWR CTL HB-1230 S3				
SPEC/MATL: Wiring Diagram		WEIGHT: APPROX. 0.00 LB.		
DRAWING #: WD-129-21-307-50				B
SCALE: 1:1	B-SIZE	DO NOT SCALE DRAWING	SHEET 1 OF 2	

EXPECTATION THAT IT WILL BE KEPT CONFIDENTIAL AND USED ONLY FOR THE PURPOSE FOR WHICH IT IS LOANED.

5.3 | UPPER CONTROLS WIRING DIAGRAM

Part No. 129-21-308-50

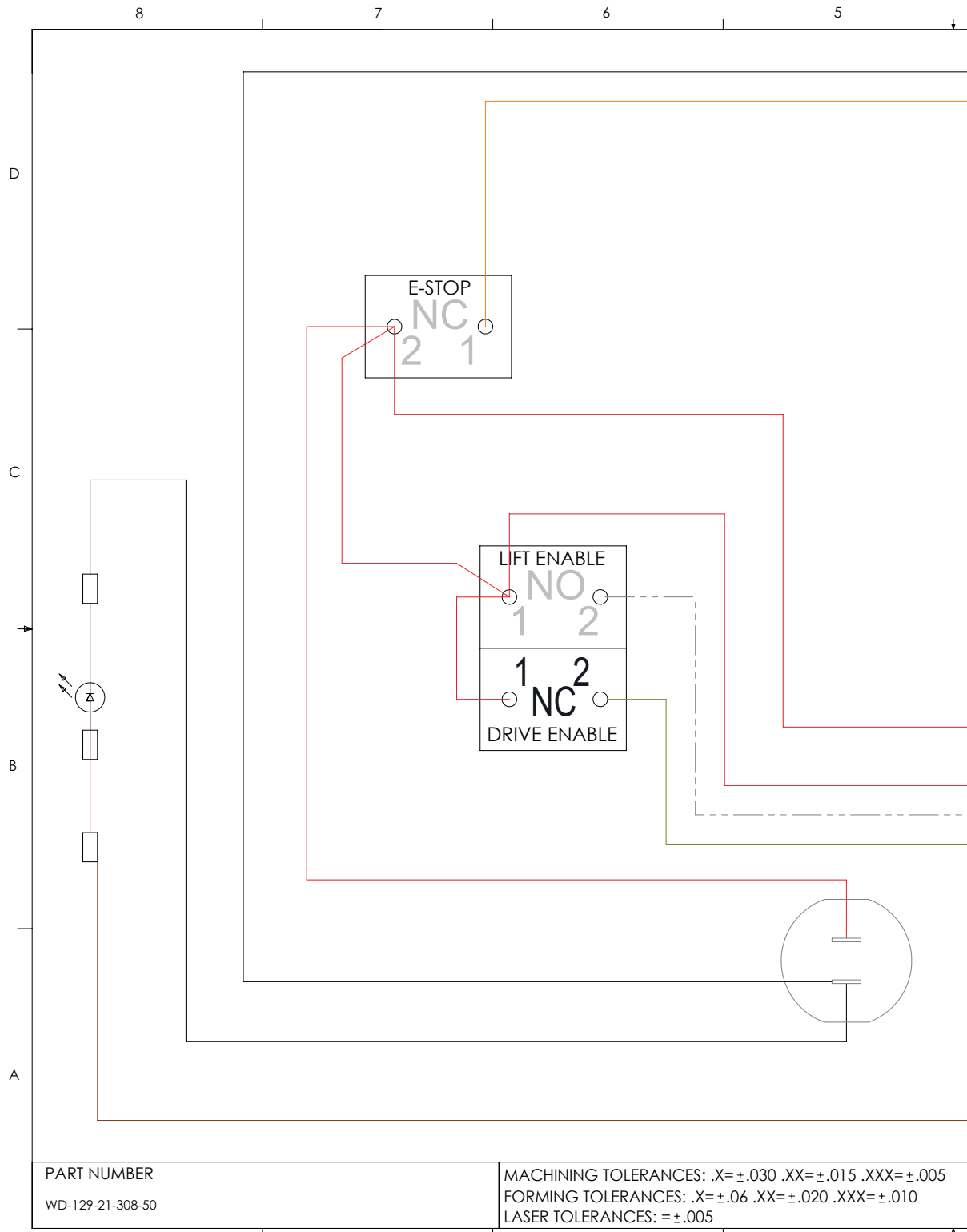

PART NUMBER
WD-129-21-308-50

MACHINING TOLERANCES: .X=±.030 .XX=±.015 .XXX=±.005
FORMING TOLERANCES: .X=±.06 .XX=±.020 .XXX=±.010
LASER TOLERANCES: =±.005

THIS DRAWING IS CONFIDENTIAL AND PROPRIETARY TO CUSTOM, EQUIPMENT AND IS LOANED IN EXPECT.

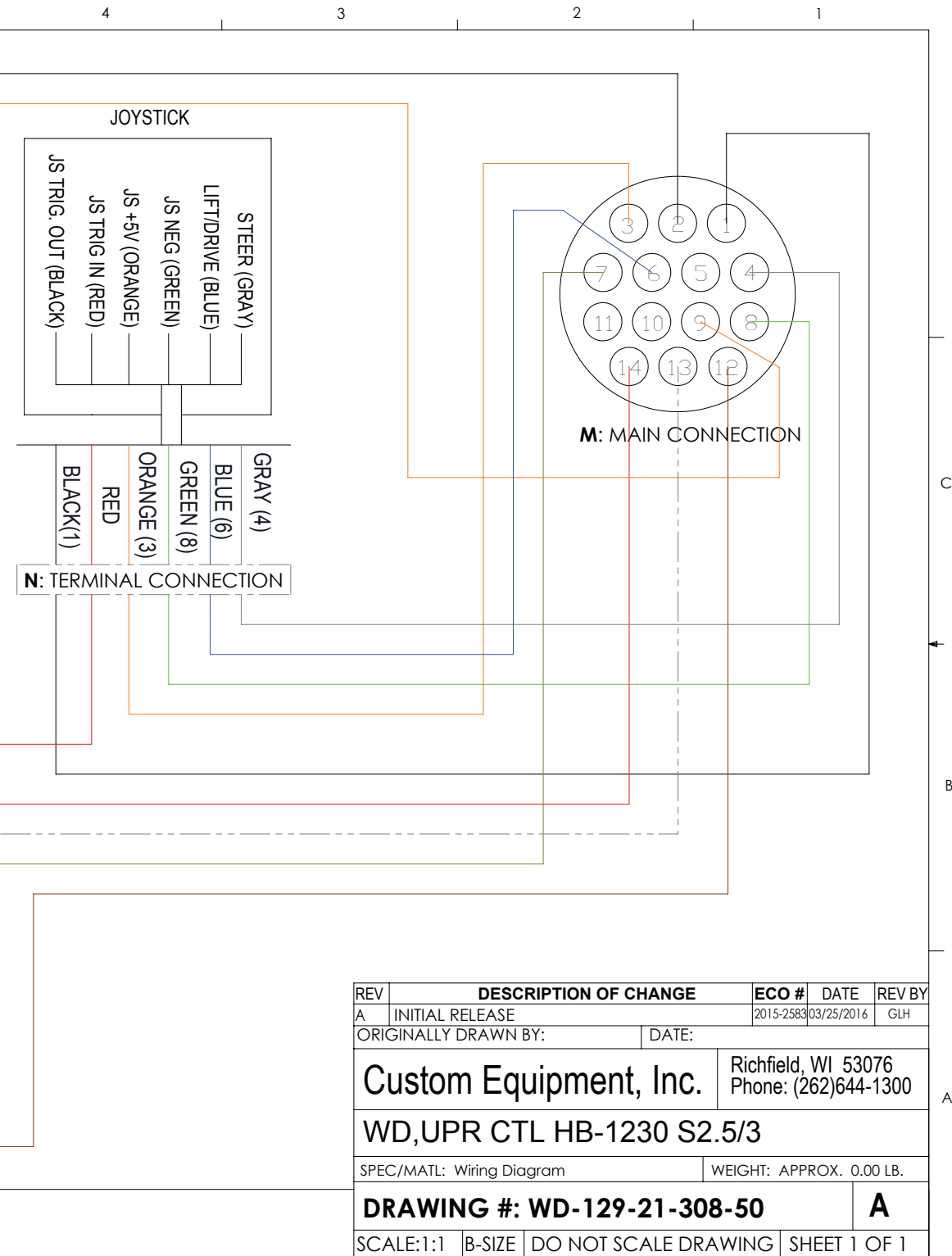

REV	DESCRIPTION OF CHANGE	ECO #	DATE	REV BY
A	INITIAL RELEASE	2015-2583	03/25/2016	GLH
ORIGINALLY DRAWN BY:		DATE:		
Custom Equipment, Inc.		Richfield, WI 53076 Phone: (262)644-1300		
WD,UPR CTL HB-1230 S2.5/3				
SPEC/MATL: Wiring Diagram		WEIGHT: APPROX. 0.00 LB.		
DRAWING #: WD-129-21-308-50				A
SCALE:1:1	B-SIZE	DO NOT SCALE DRAWING	SHEET 1 OF 1	

NOTATION THAT IT WILL BE KEPT CONFIDENTIAL³ AND USED ONLY FOR THE PURPOSE FOR WHICH IT IS LOANED.¹

SECTION 6 | TROUBLESHOOTING FLOWCHARTS

6.1 | MAIN POWER/SAFETY CIRCUIT

Flowchart: HB-830/1230-Power

Troubleshooting Step 1: Main Power

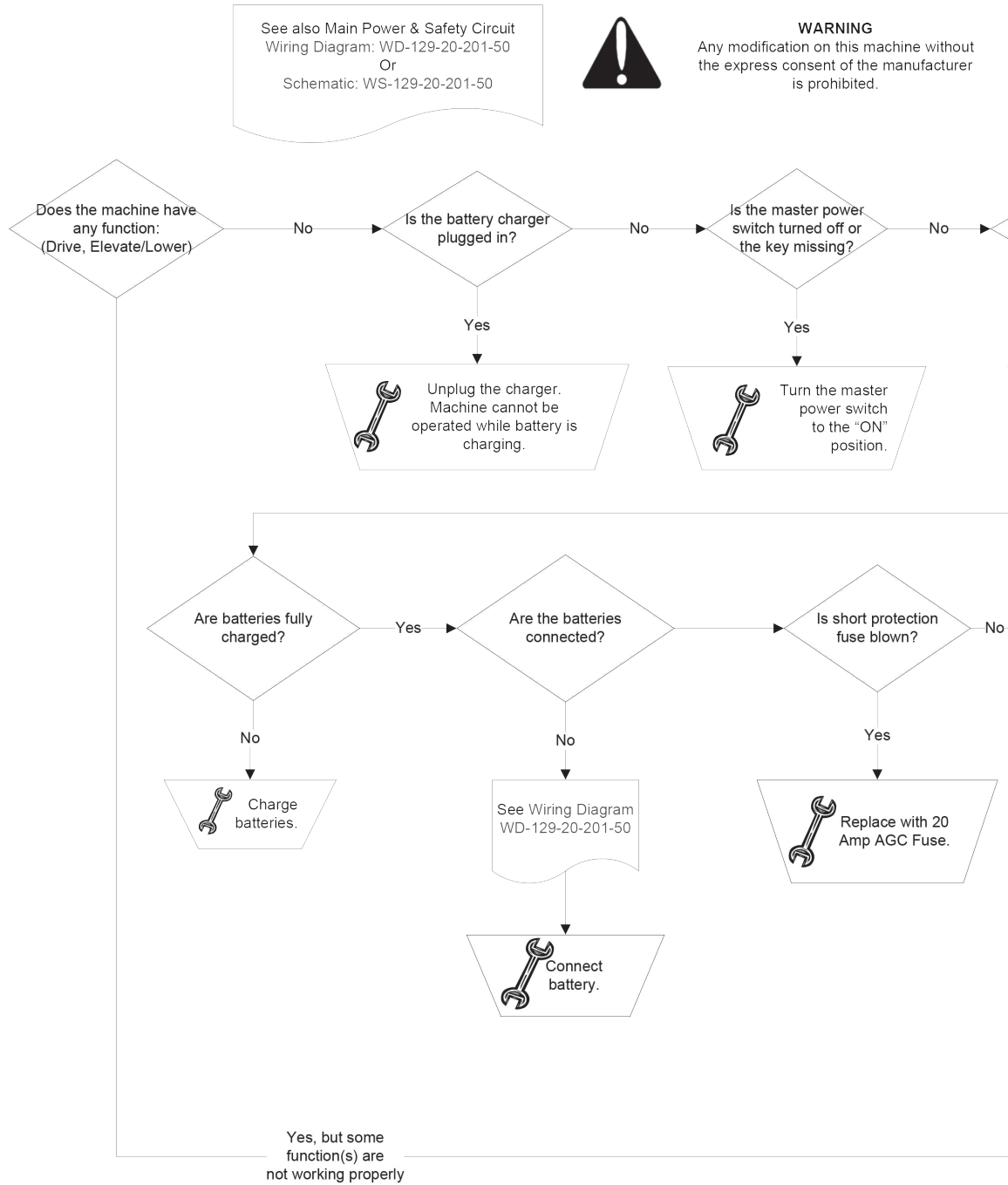

Reference Revision A



WARNING
Failure to comply with safety precautions may result in damage, injury, or death. Refer to Maintenance Manual for complete warnings

Troubleshooting Flowcharts--General Notes:

Inspect parts for visible damage as they are encountered. After each step, check if problem has been identified and/or resolved. If so, make the recommended fix or see a referenced document. If not, continue troubleshooting. If a part has been identified as needing replacement, see the Parts View to identify part number to order. If any wiring or components have been altered from the original manufacture, problems may not be identifiable.

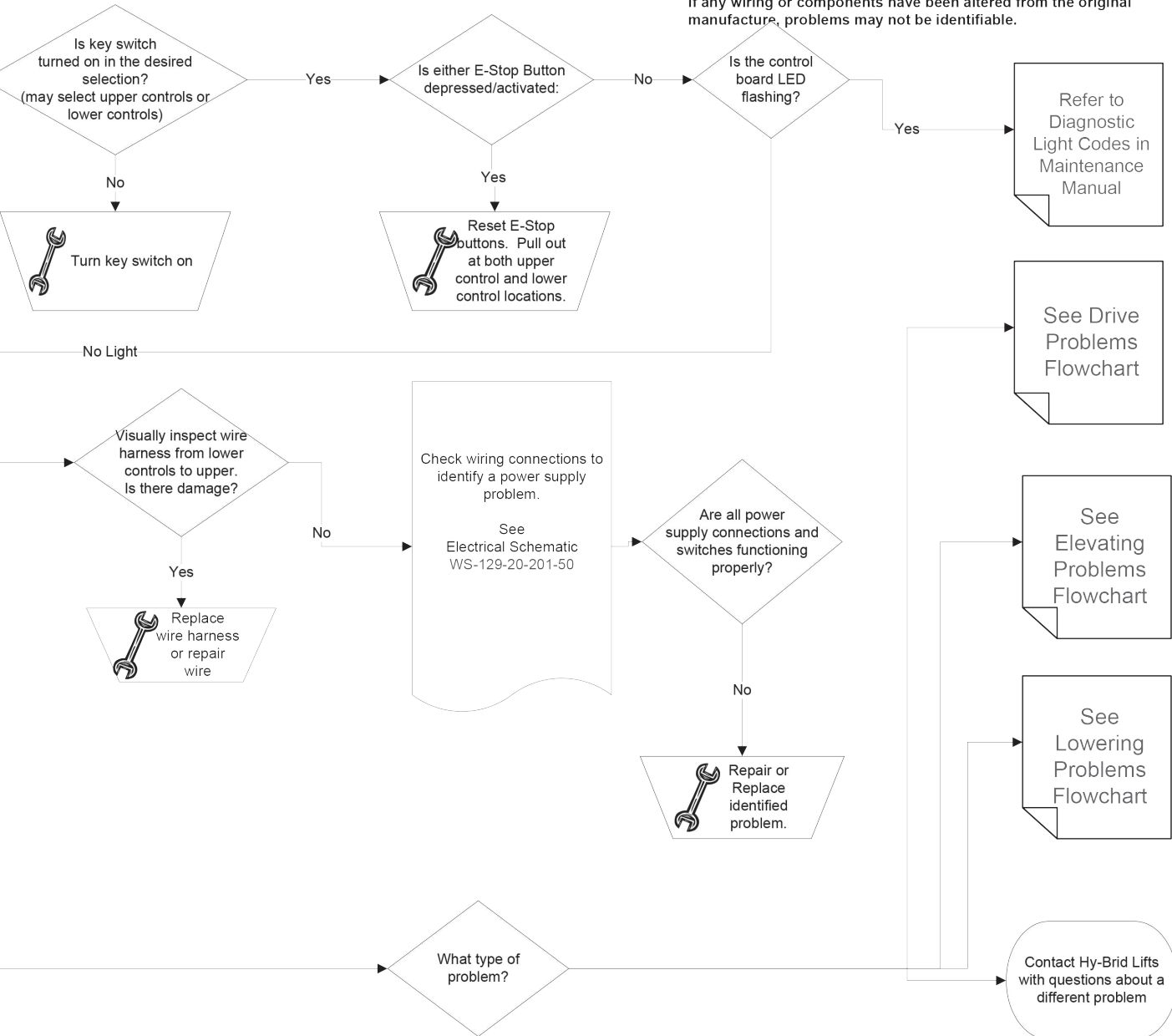

Reference Revision A

6.2 | DRIVE CIRCUIT

Flowchart-HB-830/1230-Drive

Troubleshooting Step 2: Drive

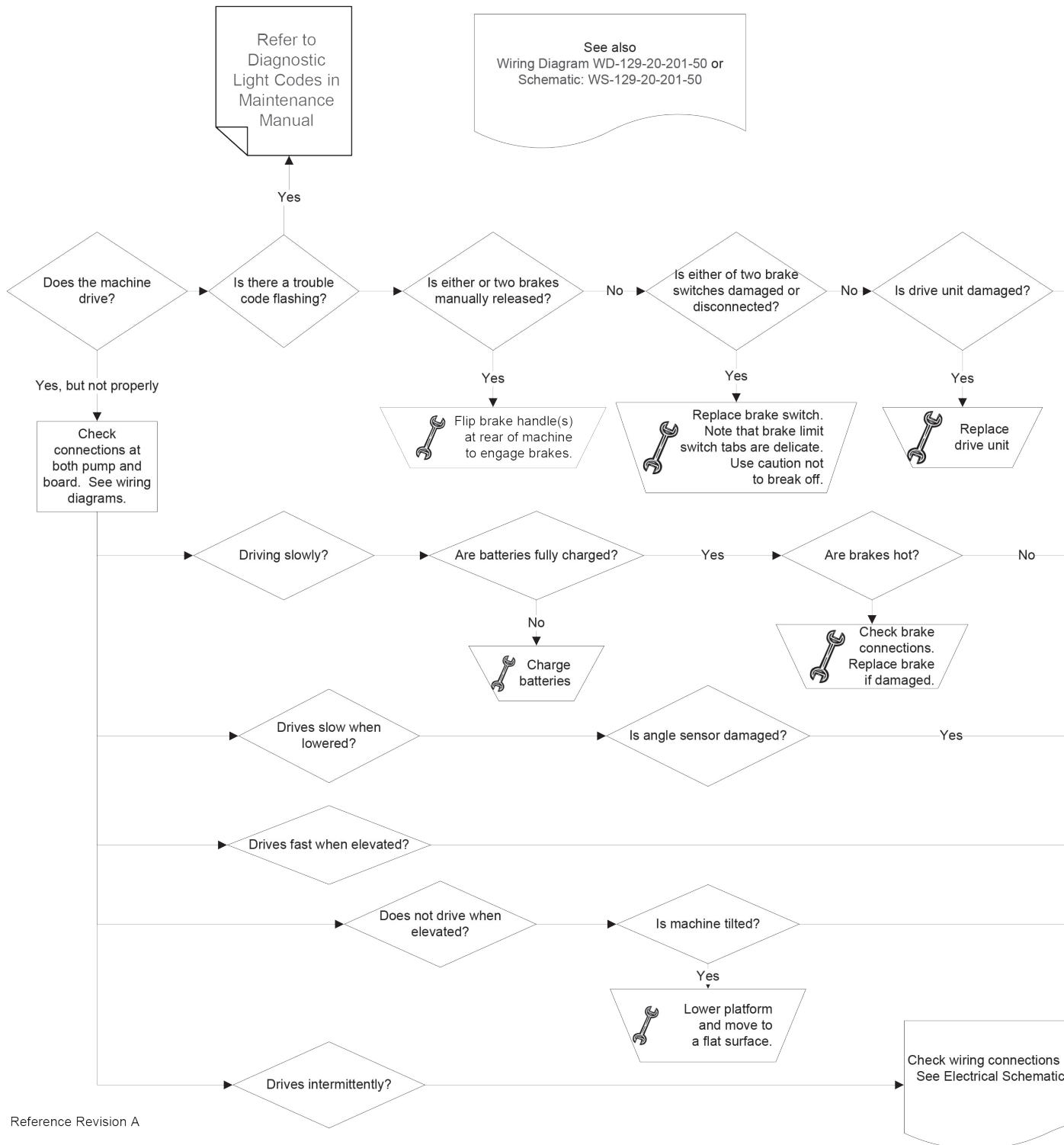



WARNING

Any modification on this machine without the express consent of the manufacturer is prohibited.



WARNING

Failure to comply with safety precautions may result in damage, injury, or death. Refer to Maintenance Manual for complete warnings

Troubleshooting Flowcharts--General Notes:

Inspect parts for visible damage as they are encountered. After each step, check if problem has been identified and/or resolved. If so, make the recommended fix or see a referenced document. If not, continue troubleshooting. If a part has been identified as needing replacement, see the Parts View To identify part number to order. **If any wiring or components have been altered from the original manufacture, problems may not be identifiable.**

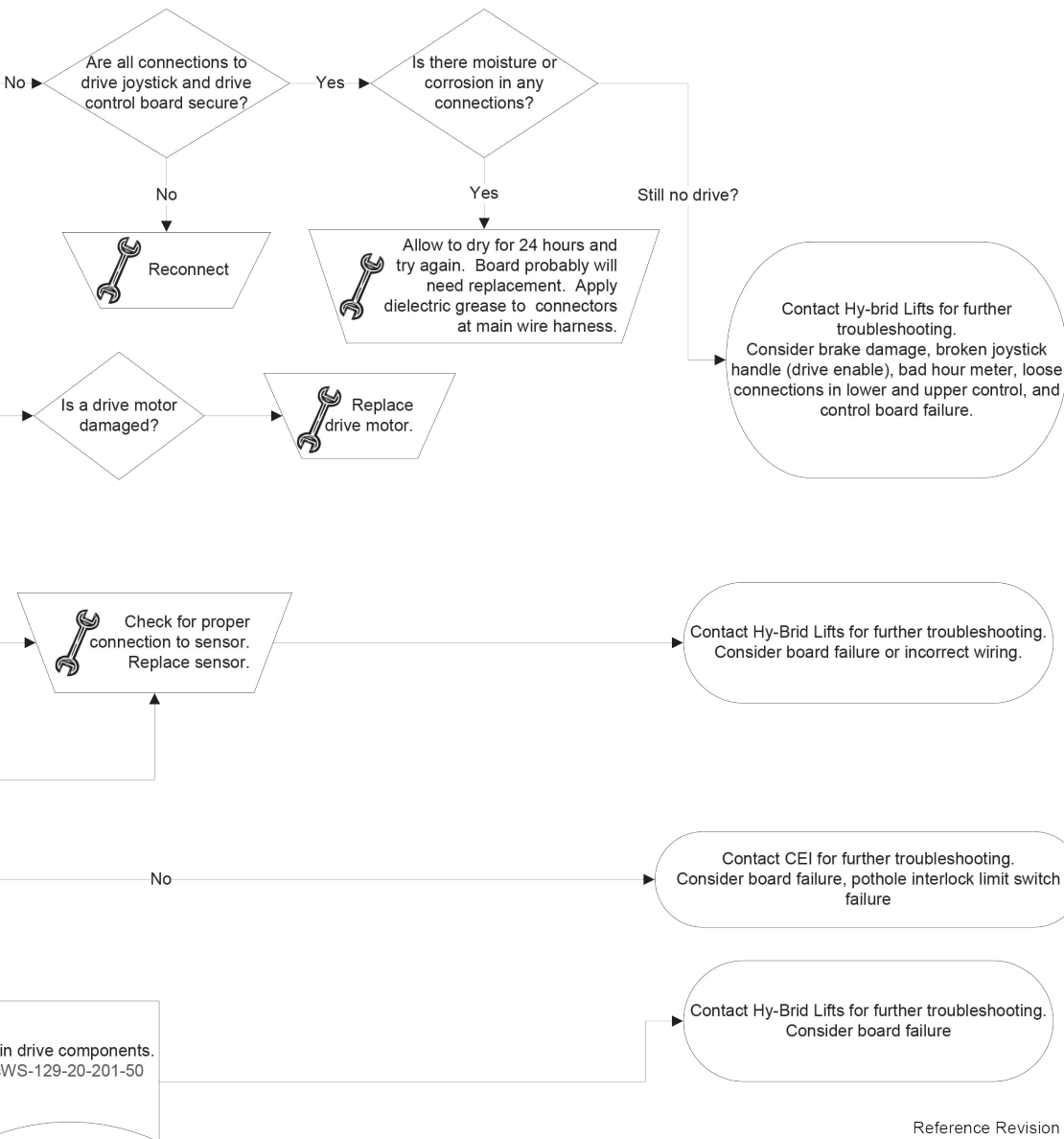

Reference Revision A

6.3 | ELEVATE CIRCUIT

Flowchart-HB-830/1230-Elevating

Troubleshooting Step 3A: Elevating

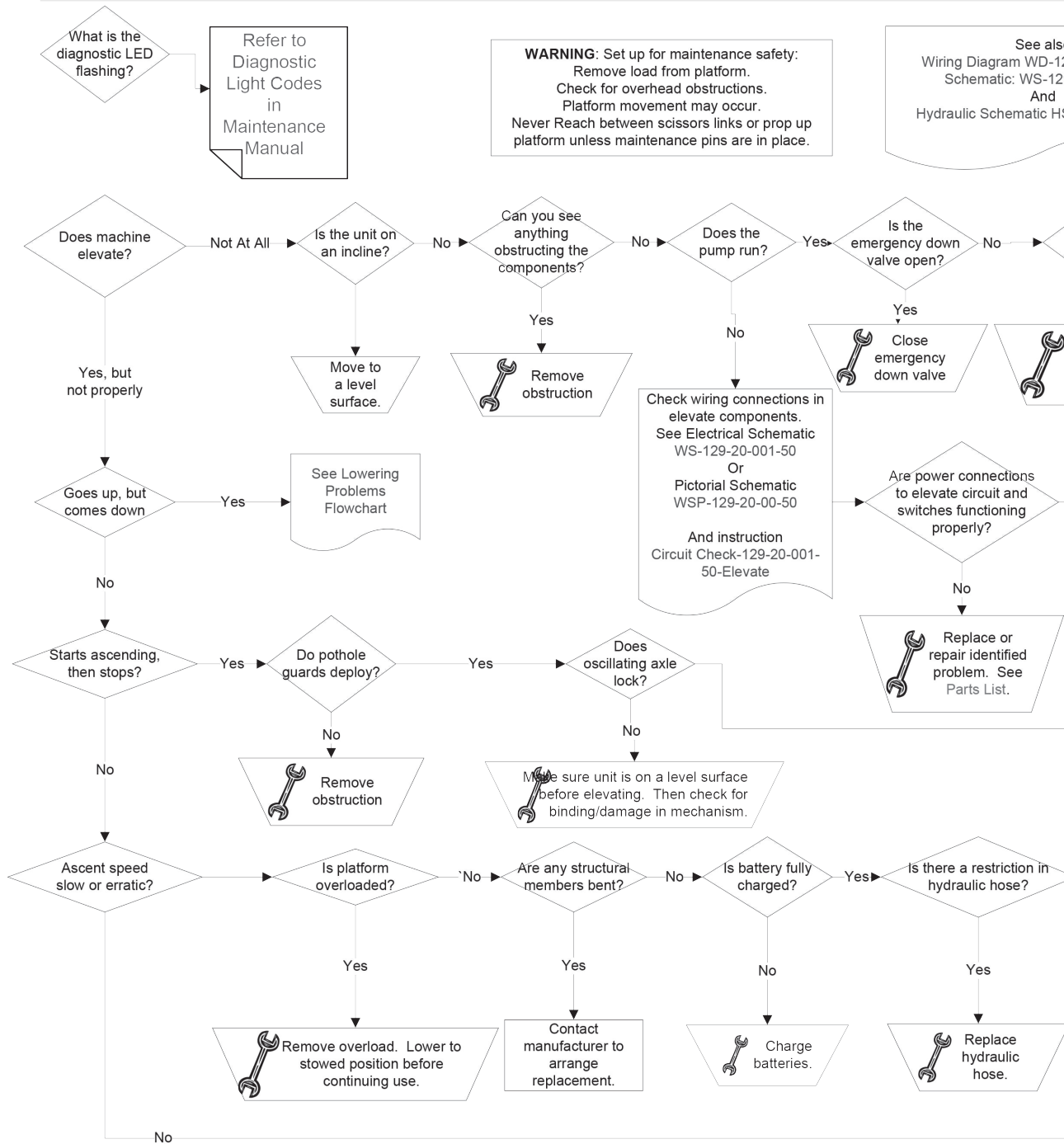

Reference Revision A

WS-129-20-201-50 or
S-129-20-201-50



WARNING
Any modification on this machine without the express consent of the manufacturer is prohibited.



WARNING
Failure to comply with safety precautions may result in damage, injury, or death. Refer to Maintenance Manual for complete warnings

Troubleshooting Flowcharts--General Notes:

Inspect parts for visible damage as they are encountered. After each step, check if problem has been identified and/or resolved. If so, make the recommended fix or see a referenced document. If not, continue troubleshooting. If a part has been identified as needing replacement, see the Parts View To identify part number to order. **If any wiring or components have been altered from the original manufacture, problems may not be identifiable.**

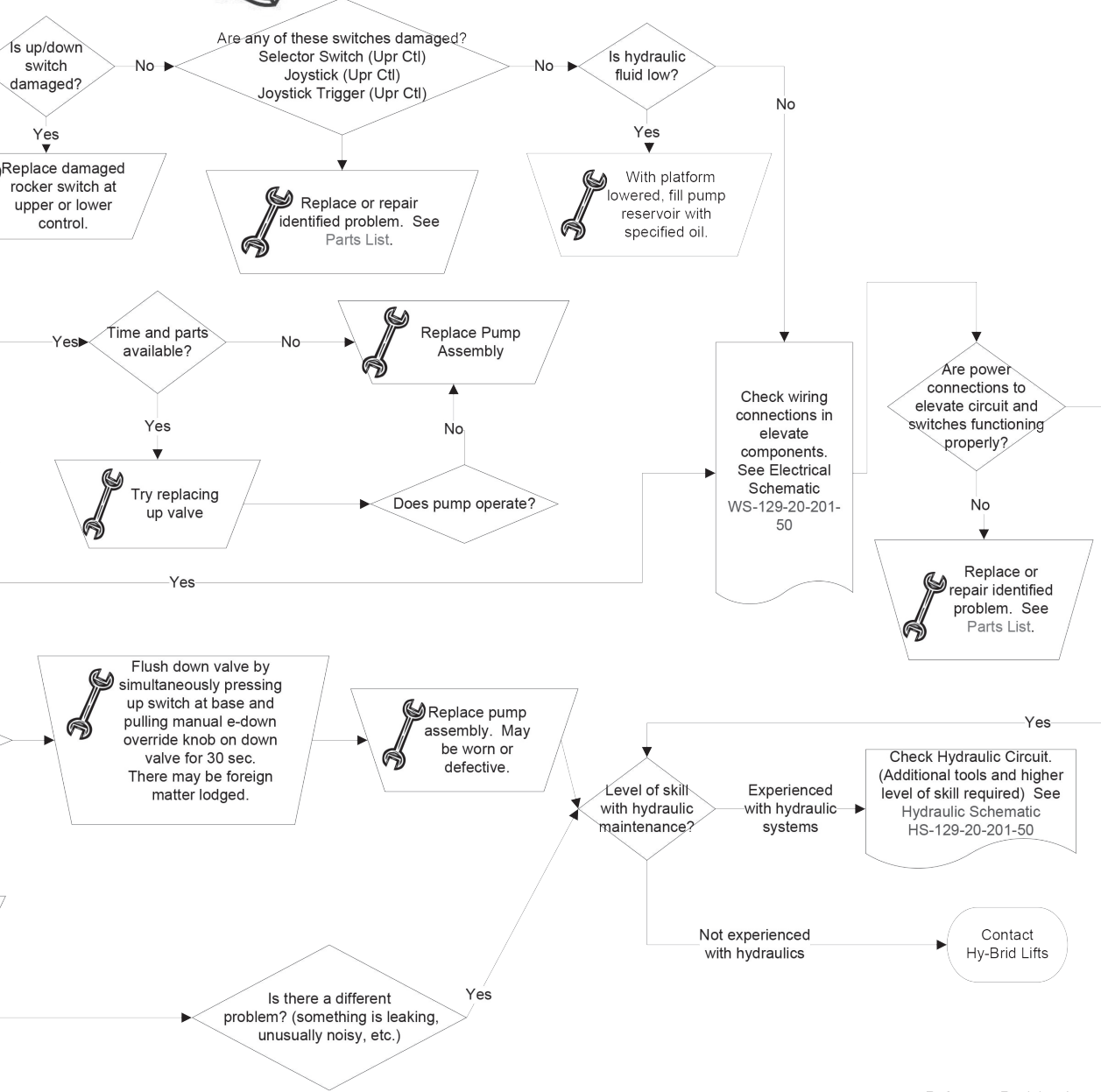

Reference Revision A

6.4 | LOWER CIRCUIT

Flowchart: HB-830/1230-Lowering

Troubleshooting Step 3B: Lowering

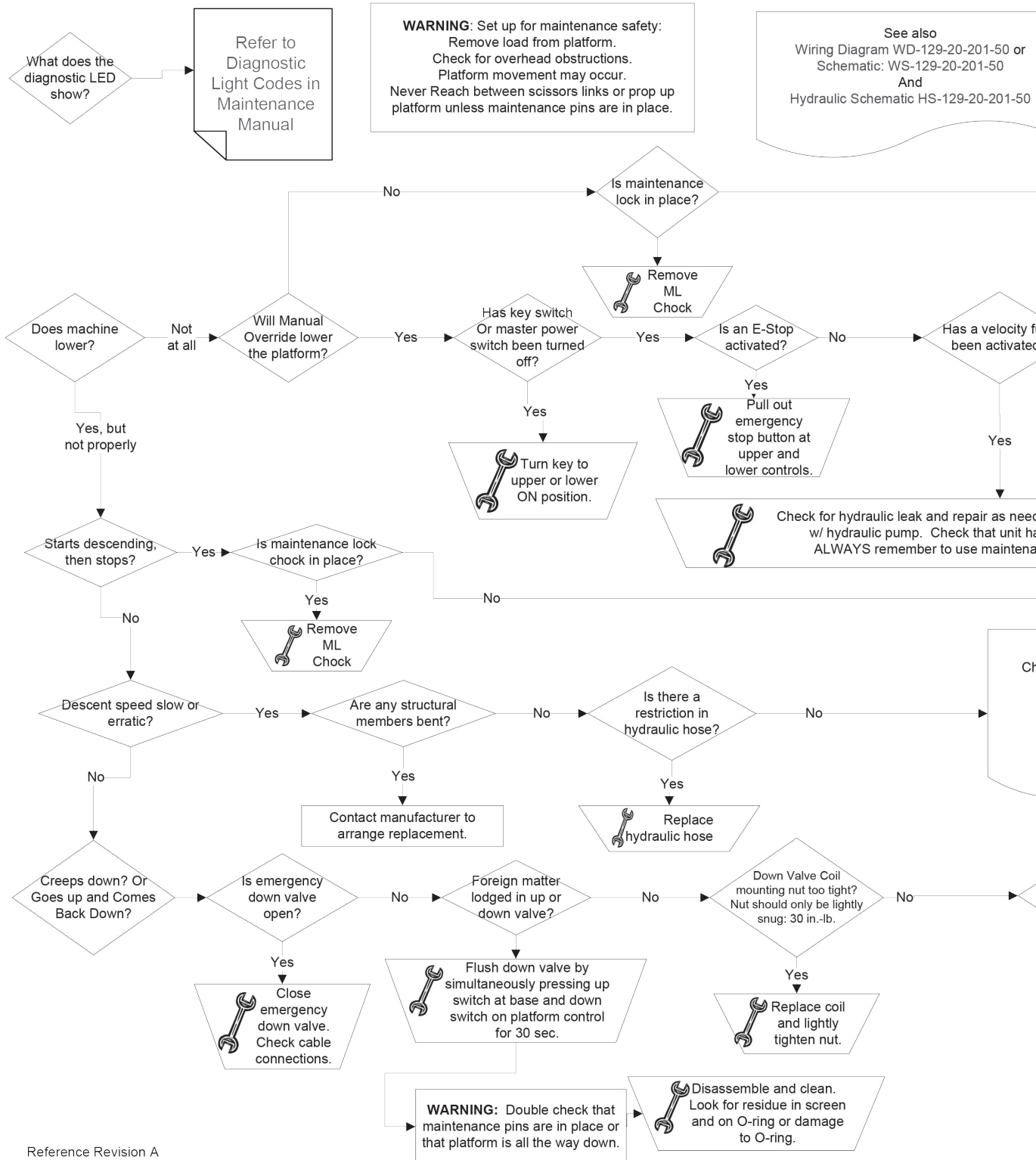

Reference Revision A



WARNING

Any modification on this machine without the express consent of the manufacturer is prohibited.



WARNING

Failure to comply with safety precautions may result in damage, injury, or death. Refer to Maintenance Manual for complete warnings

Troubleshooting Flowcharts--General Notes:

Inspect parts for visible damage as they are encountered. After each step, check if problem has been identified and/or resolved. If so, make the recommended fix or see a referenced document. If not, continue troubleshooting. If a part has been identified as needing replacement, see the Parts View To identify part number to order. If any wiring or components have been altered from the original manufacture, problems may not be identifiable.

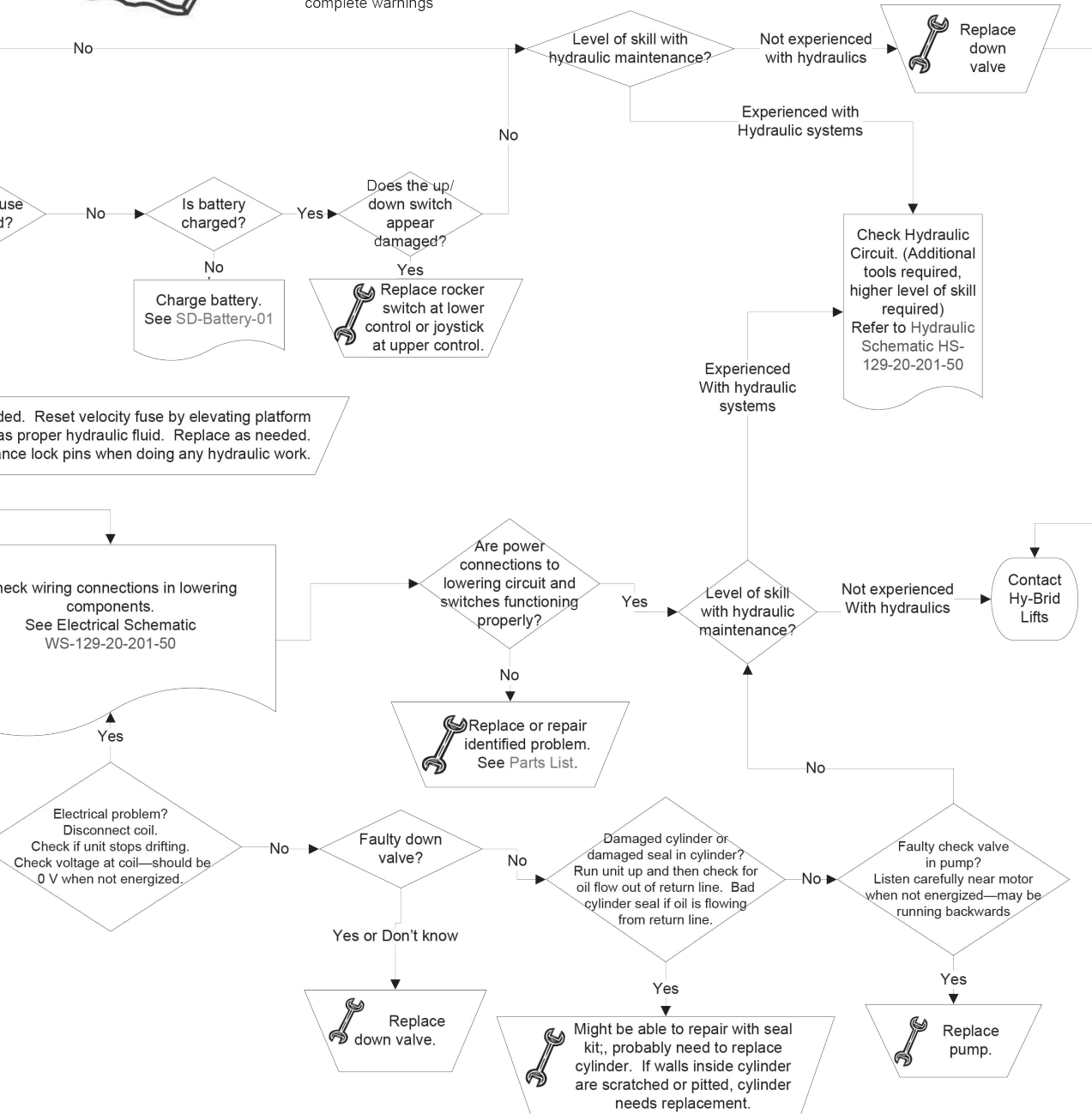

Reference Revision A

SECTION 7 | PARTS



USE ONLY MANUFACTURER APPROVED REPLACEMENT PARTS. USE OF NON-OEM PARTS WILL VOID WARRANTY.



REPLACEMENT OF THE FOLLOWING COMPONENTS WILL AFFECT THE STRENGTH, STABILITY, OR SAFETY FUNCTION OF THE UNIT: BATTERY (ELEC-047-5), HYDRAULIC CYLINDER (129-21-002-90-K), CONTROL BOARD (129-21-267-50), AND ALL STRUCTURAL COMPONENTS.

Refer to the Hy-Brid Lifts Operation and Safety Manual for decal part numbers and locations.

In addition to the decals listed in the Operation and Safety Manual, a partial list of replacement parts . These represent current model revisions. A full parts manual, part# SUPO-684 is available from Hy-Brid Lifts.

Refer to our website, www.hybridlifts.com for more complete part listings and earlier revisions. Several parts are model-, serial number-, or manufacture date-specific. Contact your dealer for replacement part availability and pricing.

Description	Part Number	Notes
ALARM, CONTINUOUS	ELEC-635-4	
BOARD,DRIVE/LIFT CTL HB-MID	129-21-267-50	BEGINNING WITH SERIAL #D08-30100
BUTTON,PUSH/PULL RED E-STOP	ELEC-071-KIT	
CHARGER,24V	ELEC-747	
CORD,NEMA 515/IEC C13,36	ELEC-639-3	
CTL,ASM LWR	129-21-307-50	
CTL,ASM UPR	129-21-308-50	
CTL,WIRE HARNESS MAIN HB-1230	129-21-311-50	
DECALS,HB-1230 S3 ANSI	129-21-315-50-K	
DRIVE MOTOR,24VELE,HB DUM,HT	ELEC-759-KIT	WHITE-YEL STRIPE/YEL LEADS BEGINNING WITH SERIAL #D08-30100
DRIVE MOTOR,24VELE,HB DUM,HT	ELEC-758-KIT	ORANGE/VIOLET LEADS BEGINNING WITH SERIAL #D08-30100
DRIVE MOTOR,BRAKE	ELEC-627-5L	
DRIVE MOTOR,BRAKE	ELEC-627-5R	

Description	Part Number	Notes
HYDRAULIC OIL	HYDR-032	Not available as a replacement part. Replace with Flomite #150, Dexron II, Mobil-DTE 2 or equivalent.
KEY,SPARE	ELEC-073EKEY	
MANUAL BOX	HARD-603	
METER,HOUR	ELEC-610-2	
METER,VOLT,24V	ELEC-610-4	
ORING,0.25 X 5	HARD-606-2	
SWITCH KNOB,MASTER DISCONNECT	ELEC-633-5	
SWITCH,KEY,3-POS MAINTAINED	ELEC-073D-KIT	
SWITCH,LIMIT,LVR MICRO	ELEC-627-6	
SWITCH,LIMIT,ROT LVR,NO/NC PO	ELEC-123-5	
SWITCH,MASTER DISCONNECT	ELEC-633-4	
SWITCH,ROCKER DPDT	ELEC-133B	
SWITCH,ROTARY MAINTAINED	ELEC-002C-KIT	
WHL,12X4 NM RUBBER W/HUB	WHEE-618-KIT	
WHL,8X2,GREY NM RUBBER	WHEE-706-KIT	
ASM,SCISSOR CYL HB12-ANSI	129-21-002-90-K	
MANUAL,PARTS HBMD S3	SUPO-684	

SECTION 8 | WARRANTY

LIMITED WARRANTY

Warranty Statement—North America Only

LIMITED WARRANTIES

Subject to the terms, conditions and limitations set forth herein, Custom Equipment, LLC (the “Company”) warrants to the first end-user (“Buyer”) that:

Limited Product Warranty

For a period of 12 months from the date that a new product manufactured by the Company (“Product”) is delivered to the Buyer, the Product will (i) conform to the specifications published by the Company for such Product as of the date of delivery; and (ii) be free of any defect in material and/or workmanship under normal use and maintenance; and

Extended Structural and Chassis Warranty

For a period of 60 months from the date that the Product is delivered to the Buyer, the chassis and other structural components of such Product will be free from defects in material and/or workmanship under normal use and maintenance.

EXCLUSIONS / WHAT IS NOT COVERED

The following items are NOT covered under this Limited Warranty:

Defects in, and damage or loss relating to, any batteries incorporated by the Company into or made a part of the Product. Any such defects, damage or loss shall be exclusively covered by the battery manufacturer’s warranty, if any. For more information regarding the battery warranty, the Buyer should contact the battery manufacturer using the contact information shown on the battery;

Damage or loss resulting from or caused by carrier handling;

Damage or loss resulting from or caused by normal wear and tear, weathering, lack of use or use with incompatible equipment or software;

Damage resulting from or caused by improper maintenance, improper handling or storage, improper use, abuse, neglect, operation beyond rated capacity, or operation after discovery of defective or worn parts;

Any part, component or assembly altered or modified in any way not approved in writing by the Company;

Damage to any equipment or parts not manufactured by the Company; and
Acts of God, accidents or any other causes beyond the Company’s reasonable control.

MAKING A WARRANTY CLAIM

As a prerequisite to making any claim under this Limited Warranty, Buyer must give the Company written notice of any suspected defect promptly after discovery. Such notice shall specifically identify the suspected defect, the original delivery date and complete Buyer identification and location information. The Company will not accept any Product for warranty service without receiving Buyer’s written notice and issuing a return goods authorization. If requested by the Company, Buyer shall return the defective Product, or parts, components or assemblies thereof, to the Company, F.O.B. Company’s designated location. All returned Products or parts, components or assemblies thereof that are replaced under this Limited Warranty shall become the property of the Company. The Company reserves the right to review Buyer’s maintenance and operation records and procedures to determine if the alleged defect(s) were due to any of the items listed in Sections 2 of this Limited Warranty. The Company shall not be liable for any claim under this Limited Warranty if Buyer fails to satisfy the conditions set forth in this Section.

EXCLUSIVE WARRANTY REMEDIES**Exclusive Repair or Replace Remedy**

The Company's sole obligation and Buyer's exclusive remedy with respect to any defect in the Product occurring during the warranty periods set forth in Section 1 of this Limited Warranty shall be for the Company, at its option, to repair or replace (or have one of its designated authorized dealers repair or replace) the Product or part, component or assembly thereof that contains a defect in materials or workmanship. The Company reserves the right, at its discretion, to use new, re-manufactured or refurbished replacement parts. Notwithstanding anything in this Limited Warranty to the contrary, the Company shall not be obligated to replace the entire Product if a covered defect can be remedied by the repair or replacement of a defective part, component or assembly. The Company shall be responsible for the cost of all parts and labor charges, up to the Maximum Labor Amount determined in accordance with Section 4(b) of this Limited Warranty, necessary to remedy such defect.

Labor Charges

If field repairs or parts replacement are necessary on any Product covered by this Limited Warranty, the Company will reimburse its designated authorized dealer for those direct labor costs incurred to perform such field repairs or parts replacement up to the maximum amount specified in the Company's current Field Service Rate (hereinafter, the "FSR") or in any 'Flat Rate Guides' or similar agreement established with the authorized dealer (such maximum amount shall be referred to in this Limited Warranty as the "Maximum Labor Amount"). Current versions of the Company's FSR and Flat Rate Guides are incorporated by reference into this Limited Warranty. For a current copy of the Company's FSR and Flat Rate Guides, Buyer should contact the Company at 1-866-334-0756. Buyer shall be responsible for any costs or fees due to the authorized dealer in excess of the Maximum Labor Amount.

DISCLAIMER OF OTHER EXPRESS AND IMPLIED WARRANTIES

Except for the limited warranties set forth in section 1 above, the company makes no other representations or warranties and hereby disclaims all express or implied representations or warranties regarding the product, including, without limitation, any implied warranty of merchantability, non-infringement of proprietary or third-party rights or fitness for a particular purpose. There are no warranties which extend beyond the description on the face hereof. No employee or representative of the company or any of its authorized dealers is authorized to modify any term, condition or limitation in this limited warranty unless such modification is made in writing and signed by an officer of the company.

LIMITATION OF LIABILITY

Notwithstanding anything in this warranty to the contrary, in no event shall the company or any of its affiliates or subsidiaries be liable to buyer for any indirect, special, exemplary, punitive or consequential damages (including lost profits, lost revenue, down time, loss of business opportunity or other economic losses), whether in an action in contract or tort (including negligence and strict liability) or otherwise, even if the company has been specifically advised of the possibilities of such damages.

Version 1.15.16

SECTION 9 | INSPECTION AND REPAIR LOG

Date	Comments

Date	Comments

HY-BRID LIFTS™

BY CUSTOM EQUIPMENT LLC

Self-Propelled Aerial Work Platform
Maintenance & Troubleshooting Manual
HB-1230
Series III

© 2017 Custom Equipment, LLC
2647 Highway 175
Richfield, WI 53076
U.S.A.
Tel. +1-262-644-1300
Fax. +1-262-644-1320
www.hybridlifts.com
Service@Customequipmentlifts.com

"Hy-Brid Lifts" is a trademark of Custom Equipment, LLC.
These machines comply with specified ANSI & CSA requirements

Revision Date: February 2017

Printed In The USA